

WINCHELSEA TOWNSCAPE STUDY



MARK MCWHA
P T Y L T D
LANDSCAPE
ARCHITECT

2/398 SMITH ST
COLLINGWOOD 3066
PH 416 1755 FX 416 0508
.....

NOVEMBER 1995



WINCHELSEA

Surf Coast Shire
Strategic Planning Library

WINCHELSEA TOWNSCAPE STUDY

SURF COAST SHIRE

CONTENTS

Page

1.0	INTRODUCTION	
1.1	Study Background and Objectives	1.
1.2	Study Area	1.
2.0	TOWNSCAPE ANALYSIS	
2.1	Town Site Context	2.
2.2	Access and Circulation	3.
2.3	Open Space Areas	5.
2.4	Historic Landmark Buildings	6.
2.5	Landscape Elements and Visual Character	6.
2.6	Public Structures	7.
2.7	Streetscape Furniture and Signage	8.
2.8	Ground and Paving Elements	8.
2.9	Traditional and Native Theme Planting	8.
3.0	TOWNSCAPE MASTERPLAN	
3.1	Broad Townscape Opportunities (Concept Plan)	11.
3.2	Barwon River Area	12.
3.3	Town Centre	14.
4.0	FURNITURE DESIGN GUIDELINES	
4.1	Site Furniture	16.
4.2	Signs	17.
5.0	OPEN SPACE STRUCTURES AND ARCHITECTURAL GUIDELINES	
5.1	Open Space Structures	18.
5.2	Architectural Streetscape Guidelines	18.
6.0	IMPLEMENTATION	
6.1	Priorities for implementation and staging	20.
6.2	Cost Estimates	21.
7.0	APPENDICES	
7.1	Acknowledgments and Study Team	22.

WINCHELSEA TOWNSCAPE STUDY

SURF COAST SHIRE

LIST OF FIGURES

1. Location Plan
2. Existing Township Area Plan
3. Existing Conditions Plan
4. Historic Landmark Buildings - Photo Sheet
5. Landscape Elements - Photo Sheet
6. Willis Street looking South-west - Sketch
7. Willis Street view of Globe Theatre - Sketch
8. Willis Street (b/w Harding and Austin Streets) - Sketch
9. Main Street Shops (b/w Palmer and Hesse Streets) - Sketch
10. Main Street looking North-east - Sketch
11. Civic Structures - Photo Sheet
12. Streetscape Furniture - Photo Sheet
13. Signage - Photo Sheet
14. Ground Elements - Photo Sheet
15. Traditional Theme Trees - Photo Sheet
16. Native Theme Trees - Photo Sheet
17. Broad Townscape Concept Plan
18. Barwon River Area Action Plan
19. Town Centre Action Plan
20. Section through southbank Picnic Area to proposed Rotunda
21. Sketch view of Proposed Picnic Shelters to North-west Bank
22. Sketch view of proposed viewing deck on North-east Bank
23. Public Open Space Structures
24. Furniture Details
25. Architectural Streetscape Guidelines

1.0 INTRODUCTION

1.1 STUDY BACKGROUND AND OBJECTIVES

A planning strategy incorporating Winchelsea township was prepared by USE Consultants in 1993.

The Surfcoast Council recognised that benefits would result in the preparation of detailed Concept or Development Plans and Guidelines for the township area.

The practice of Mark McWha Pty Ltd, Landscape Architects was engaged by the Shire in May 1995 to prepare this Townscape Study.

The objectives for the study included:

1. To enhance the intrinsic character of the township area and in particular the area abutting Princes Highway and Barwon River.
2. To identify a town theme to be used in the uniting of the towns image. The theme to be used in future promotion and development of the town.
3. To identify the main activity areas of the town and recommend appropriate community connections between these elements.
4. To provide guidance for the enhancement, integration and development of the Civic and Barwon River precincts.

1.2 STUDY AREA

The Township of Winchelsea has a very special rural town character. It is located 35 kilometres west of Geelong, as shown on figure 1.

There is a special emphasis on its strategic location on the Princes Highway, and the Barwon river, both as a local regional focus, and as a potential tourist stop on a major tourist route. There are many opportunities and needs for enhancement, both for the benefit of the local residents and community, and for the visitor.

The study area is defined generally by the township boundaries which have been extended to include the adjacent rural-residential areas of Quambatook and Barwon Park Estates. See Figure 2, Existing Township Area Plan.

2.0 TOWNSCAPE ANALYSIS

This section of the report provides a summary of the investigation of existing townscape conditions, in terms of site context (location, topography and landuse), existing visual character, historic landmark buildings, townscape features and elements, street furniture, paving, tree planting themes and indigenous vegetation.

2.1 TOWN SITE CONTEXT (Location, Topography, Land Use)

This report accepts and builds upon the assessment and recommendations of the 1993 planning study by USE Consultants - the Winchelsea Strategy Plan.

Winchelsea is located on the Princes Highway at its crossing point on the Barwon River. It is the first 'country town' with significant size and character, that a traveller reaches from Melbourne, and there is great tourism potential to capitalise on that strategic location.

The town is surrounded by broad-acre farming on a relatively flat rural landscape. The highway passes fairly quickly into the 'town proper' which projects a strong historical and rural character, with a range of simple human scale heritage buildings - the single storey verandahed store, the pub, farm implement storage and sales yards, and then into the civic precinct with the former library and Shire offices.

The fairly abrupt winding dip down to the Barwon River, that physically separates the town into two halves, provides a interesting visual contrast with its narrow open space corridor of majestic river red gums.

Many of these images are fleeting for the visitor, and much that is of interest is away from the main highway. For example, the historic railway station, the churches, historic Barwon Park and the Barwon River bridge itself are not seen from the road.

Upgrading of the town facilities and features, and improving access and convenience to carparking areas, will improve the town amenity and identity for visitors and residents alike.

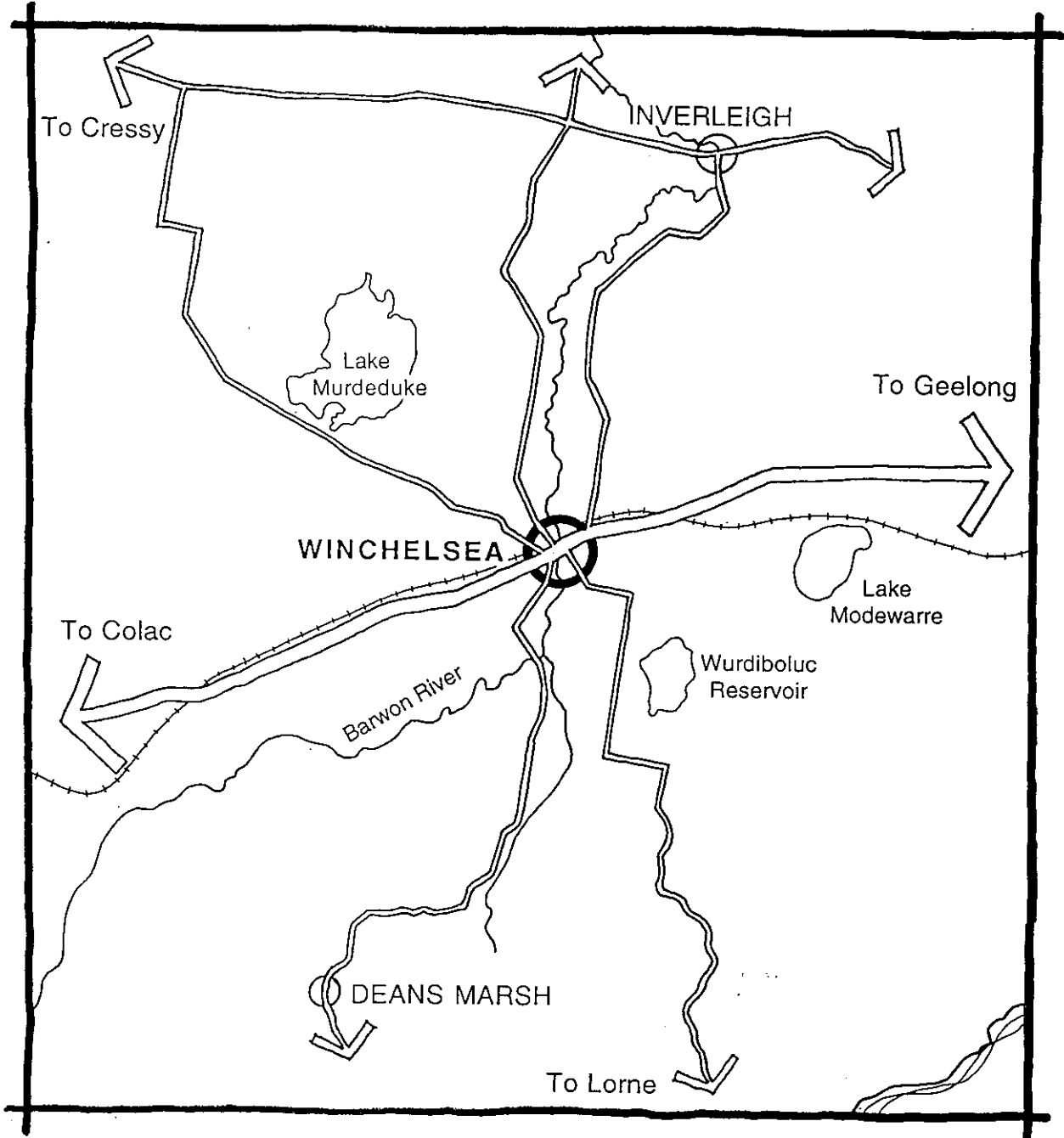

WINCHELSEA
TOWNSCAPE
STUDY

LOCATION PLAN Figure No. 1



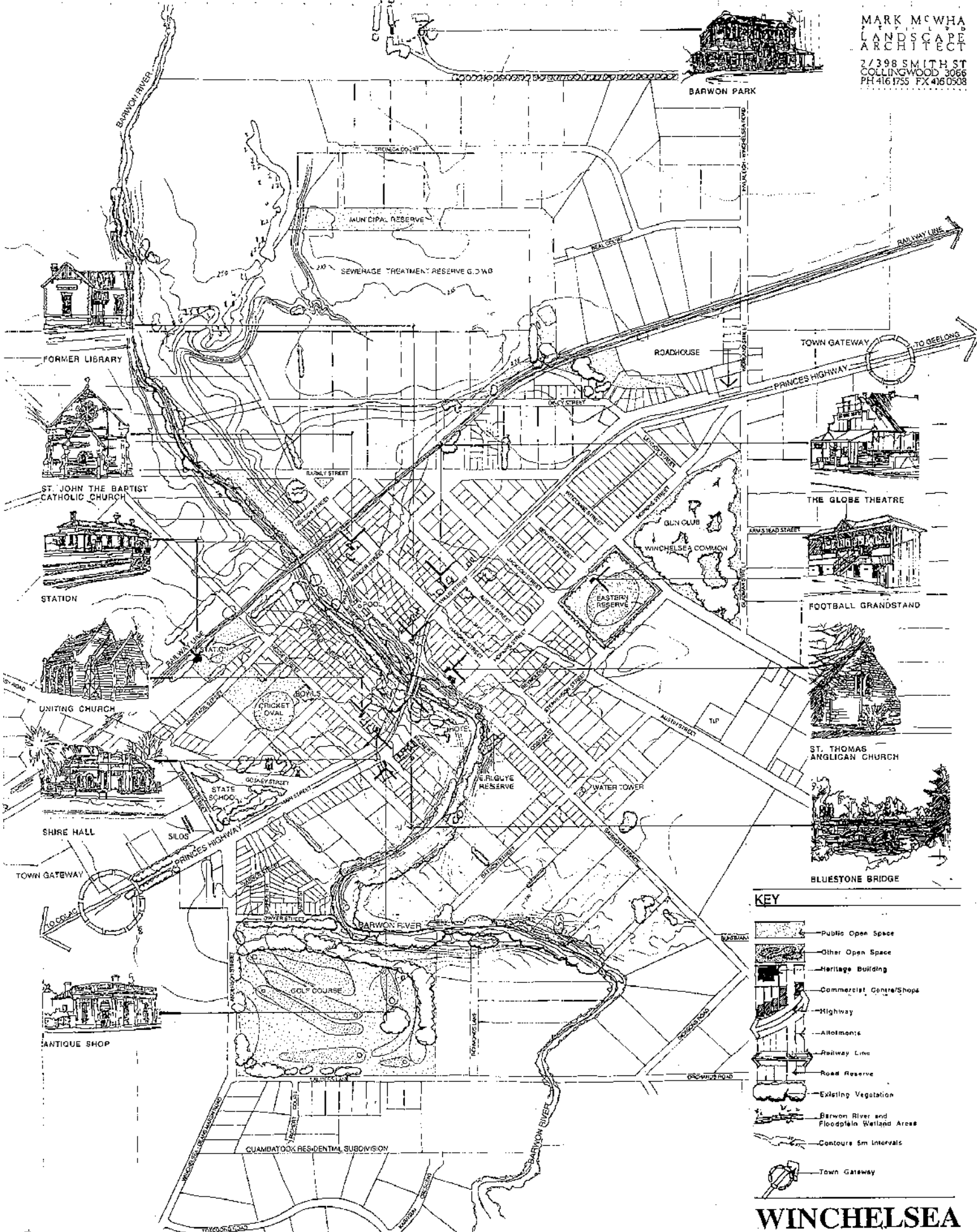

KEY

- Public Open Space
- Other Open Space
- Heritage Building
- Commercial Centre/Shops
- Highway
- Allotments
- Railway Line
- Road Reserve
- Existing Vegetation
- Barwon River and Floodplain Wetland Areas
- Contours 5m Intervals
- Town Gateway

WINCHELSEA TOWNSCAPE STUDY

**EXISTING TOWNSHIP AREA PLAN
(Existing Town Features and Historic Buildings)**

Figure No. 2



2.2 ACCESS & CIRCULATION

This section is divided up into the main categories of people movement around and through the township.

Road

The Princes Highway passes straight through the town and is the main point of arrival for visitors. The sense of arrival from both the Geelong and Colac directions is not strong and could be enhanced. The town is announced by the new 'Surfcoast Shire' signs, and then 'community art' signs and the usual Vicroads derestriction signs. There is however, a fairly rapid transition from the open rural landuses into the township centre.

Secondary Town Entry Roads include:

- Worland Street (Inverleigh-Winchelsea Road)
- Barwon Terrace (Torquay)
- Anderson Street (Deans Marsh Road)
- Hesse Road
- Cressy Road

Apart from Worland Street which is used to access historic Barwon Park, the vast majority of visitors pass along the Highway (Main Street), or use Anderson Street for access to or from the Lorne direction.

Parking

There is on-street parking on both approaches into town, parallel parking on the Geelong side, and parking in the service roads on the Colac side. Both seem to cater adequately for access to the isolated shops on the town approaches.

Parking and access to the existing toilet facilities and picnic facilities north of the Bridge is more random and not clearly organised.

There is good 60° angle parking in front of the retail core area, with convenient central trailer and van parking along the middle spine. The exit lane from the Highway to this area is fairly abrupt after the bridge and clear signage and other visual clues are required to highlight the access point. The adjacent gravel expanse and circular drive in front of the Barwon Hotel is less organised, but also provides good access to the picnic area on the south side of the river. A Vic-line bus stop pull-off on the Highway verge is located immediately opposite the shops.

There is significant parking area behind the former Shire Hall, in close proximity to the river open space, but few visitors would be aware of its existence.

Railway Access

The Winchelsea station is a building of great historic character, and forms a great point of arrival. Some of that historic character has been removed with the rationalisation of the station service structures and 'outbuildings', however there are many opportunities to reinforce the character of this special precinct. A strengthened avenue treatment along Hesse Street into the town centre would further enhance this sense of arrival.

The railway line forms a physical boundary along the north west of the town.

Bicycle and Pedestrian Access

There has been some provision of shared footways and cycle tracks through the town.

There is a designated bicycle track along Deans Marsh Road from the Highway which leads out adjacent to Golf Course. This provides good local access, but the Highway forms a barrier across to the State School on the north side.

A very good bitumen sealed shared footway extends along the north side of the Barwon River open space, from the bridge to the 'Leo's project site at Barkly Street, with the possibility of linking into the 'quiet' adjacent residential streets and rural fringe paddocks. Private ownership of land beyond presently prevents further linking along the river to the historic Barwon Park homestead.

There are informal 'goats track' type trails along the river edge on the Barwon Terrace side, (where the verge is very steep and overgrown), the Barwon Hotel side and the Shire Hall side,. Properties on the hotel side of the bridge extend right down to the river and presently prevent the provision of formal trails beside the rivers edge. The provision of future public access along the river frontages is highly desirable.

The Highway bridges provide the only formal bicycle and pedestrian access points across the river in the town centre. Seasonally, when the river level drops, there are 'stepping stone' crossing points across the river, including a reasonable access point connection near Mercer and Armytage Streets. This could be further improved to form a more stable pedestrian 'ford' crossing.

The Princes Highway forms the other main barrier to restrict pedestrian and cycle movement in the town. The crossing points, especially at Hesse Street, need careful attention. The path connections from the river picnic area to the shopping centre area are not well defined. There is a clear need for improved pedestrian and cycle access in this area.

2.3 OPEN SPACE AREAS

The town is well provided with both passive and active open space areas, which all contribute positively to the social, recreational, visual and environmental character of the town.

Barwon River Environs

The open space corridor adjacent to the river provides a real focus for the town. As previously discussed, access is restricted, particularly on the 'south' side of the river. The remnant indigenous vegetation including the large majestic river red gums provide a striking contrast with the more formal traditional streetscapes with exotic trees.

Picnic areas and facilities are concentrated on the northern segment leading around to the town swimming pool. This is a very pleasant space, although the facilities including the play equipment, the picnic shelter, picnic tables, and the pool area and buildings are all in need of upgrade.

The picnic area on the south bank below the Barwon Hotel is less developed and structured, with historic farm implements scattered through the space, extending the theme established by the hotel. Provision of a toilet facility has been considered for this area, and together with improved carparking and access arrangements, and picnic facilities, this area would provide a very useful balance to the area diagonally opposite.

There is a significant opportunity space, as yet undeveloped, in the open space area below the Shire Hall.

The open space area in the central township area is shown on the Existing Conditions Plan, figure 3.

Eastern Reserve

This active recreation area contains a football oval and netball courts. The area derives its special visual interest from the older grandstand and memorial gates, on axis with Bennett Street, and the surrounding perimeter planting with mature cypress and pine trees. The facilities themselves are in some need of upgrade.

Cricket Oval and Bowls Club Area

This important open space is clustered together with the community centre, and provides a good balance of facilities to the oval previously discussed.

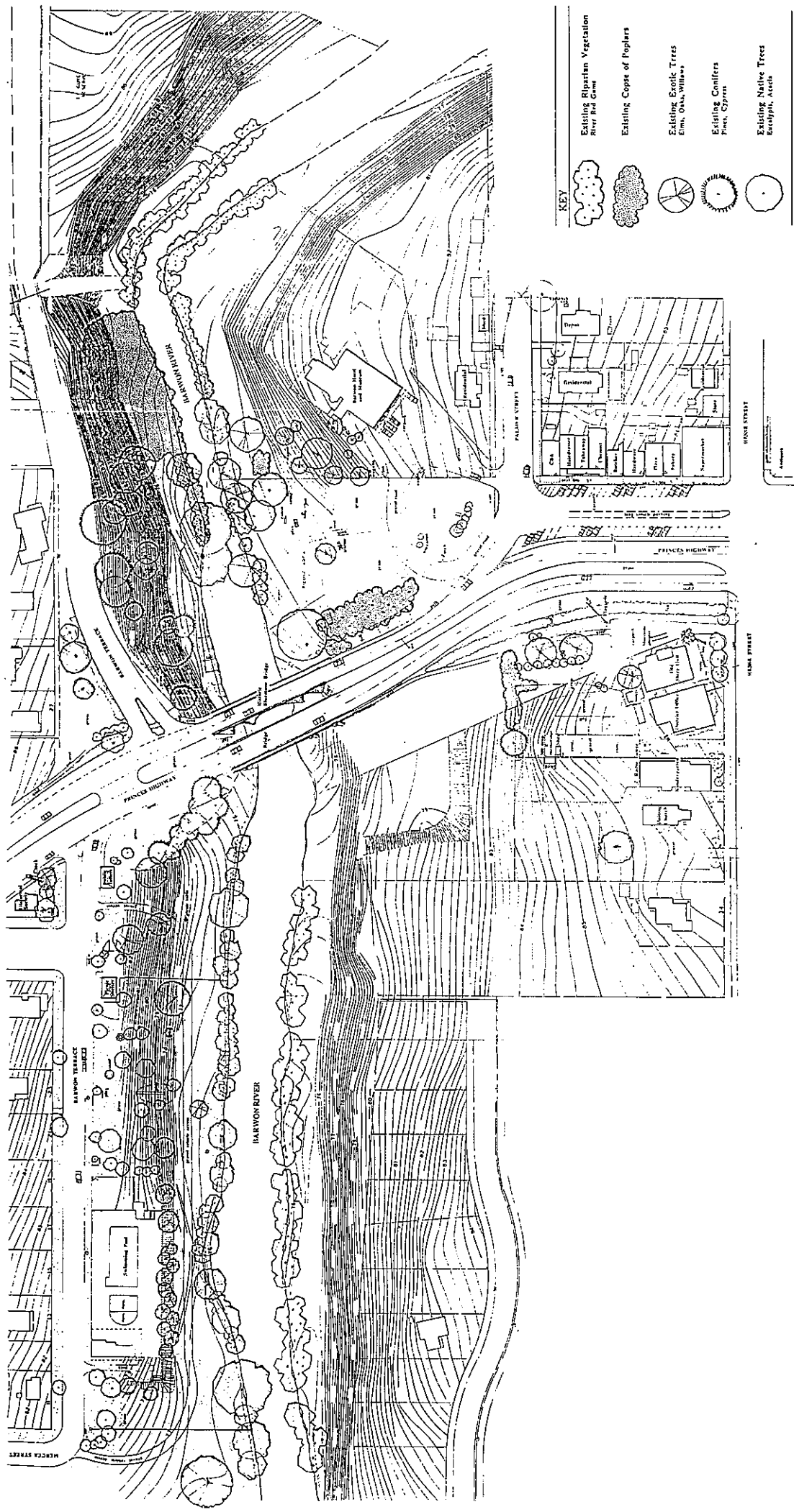

WINCHELSEA TOWNSCAPE STUDY



EXISTING CONDITIONS PLAN

Figure No. 3

Winchelsea Common

Other reports have dealt with the high natural values and environmental significance of this area. The great old river red gums with significant areas of regeneration, and grass and herb layer, provide a very important natural resource for the township, so close to the town centre. The gun club activities, and the associated ad hoc clutter of sheds, barriers and targets, have provided an important facility up to date, but their activities certainly compromise the environmental qualities of this reserve.

The increased level of residential development immediately adjacent to the area will put additional pressure on this use of the area. In the near future, it will be important for the gun club to seek a new location, preferably still close to Winchelsea, and there will be the need to undertake actions to further enhance and manage this important environmental area.

2.4 HISTORICAL LANDMARK BUILDINGS

Winchelsea derives much of its visual character and sense of identity from its important stock of older buildings. The town has maintained a strong historic identity, owing to the number of intact heritage buildings within the town. Some of the most notable historic buildings include:

- The 'Bluestone' Shire Hall
- Historical Society (former Library)
- Globe Theatre
- Winchelsea Railway Station
- St John the Baptist - Catholic Church
- St Thomas - Anglican Church
- Uniting Church

A representative range of those buildings is shown on figure 4. It is important that new development does not compromise the quality and scale of these buildings, and that buildings in public ownership be maintained and upgraded.

2.5 LANDSCAPE ELEMENTS AND VISUAL CHARACTER

There are a number of landscape elements scattered throughout Winchelsea which reinforce a strong sense of identity. They include civic elements such as the historic Barwon River bridge, memorials, and a range of 'vernacular' townscape elements, such as timber fences, farm machinery displays, and bluestone pitcher gutter channels. The galvanised iron wheat silos on Princes Highway form a dramatic landmark image to the Western town entry.

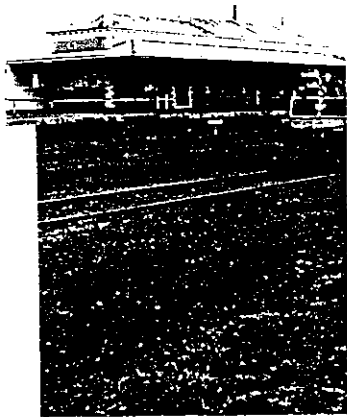

Station

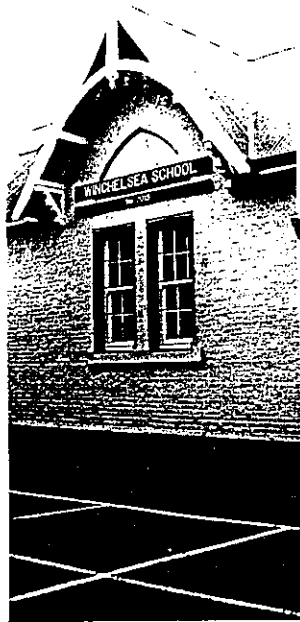

Winchelsea State School

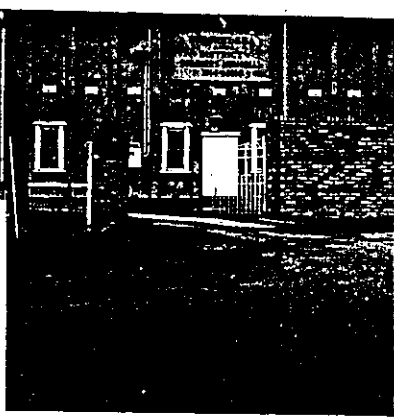

Football Grandstand

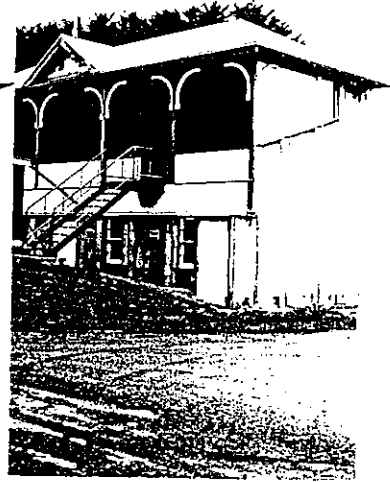

Football Grandstand

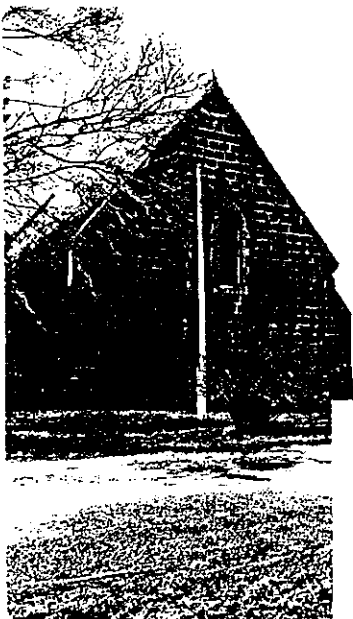

St. Thomas Anglican Church

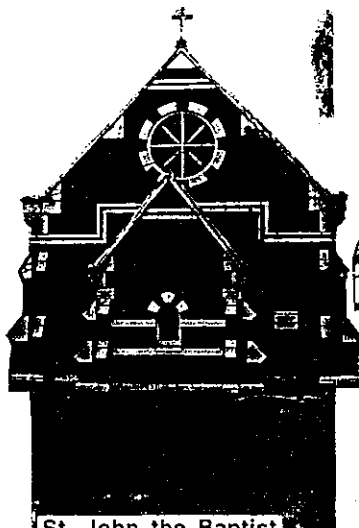

St. John the Baptist Catholic Church

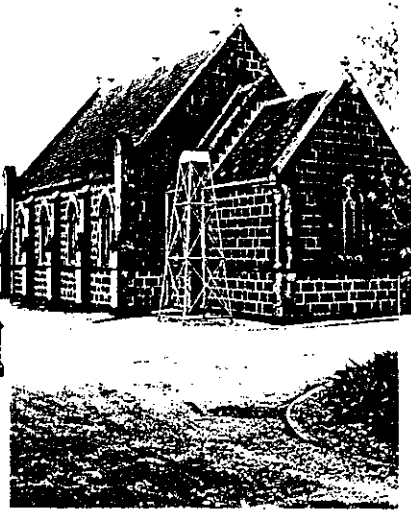

Uniting Church



Former Library



Barwon Hotel



Winchelsea Hotel



Willis Street Shops



Antique Shop

MARK MCWHA
LANDSCAPE
ARCHITECT
2/398 SMITH ST
COLLINGWOOD 3066
PH 416 1755 FX 416 0508

HISTORIC LANDMARK BUILDINGS WINCHELSEA TOWNSCAPE STUDY



Figure 5 shows a number of these items which all contribute to the character of the town.

A number of sketches of the existing streetscape character are shown on figures 6 to 10. These annotated sketches help to visually summarise the special townscape identity of Winchelsea.

One of the most dominant images of the town is that of the historical Barwon Bridge. Built in 1867 and opened by the Duke of Edinburgh, the triple bluestone arches across the Barwon River have become a recognised visual image that has been repeated in community art for the town.

2.6 PUBLIC STRUCTURES

The quality and character of the public facilities and structures, such as toilet blocks, picnic shelters, etc. help to contribute to the general civic amenity and identity. Several of these buildings are shown on the figure 11 photo sheet.

Some of the buildings and facilities in Winchelsea have developed on an ad hoc basis, and do not compliment the character or quality of the buildings highlighted in the previous sections.

The following is a list of comments related to the individual elements:

Public Toilets: (Located on north west river bank above picnic area). The building is a hip roofed structure of red 'clinker' brick construction, with olive colour-bond steel deck roof. A corrugated iron roof would have been more consistent with the town character, but the building is simple and in reasonable condition. A posted verandah could further improve the building form and use.

Picnic Shelter: (North-west picnic area). This is a rustic timber post and mud brick structure with low pitched corrugated iron roof. Mud brick is not a local building material, and the condition of the building is deteriorating. As and when new picnic facilities and shelter are provided in time, this building should be removed.

Public Swimming Pool Buildings: Cream brick buildings with flat steel deck roof, white metal gutters and timber verandah posts. These buildings are of low visual quality, and require major upgrade, especially considering their prominent location on the river and the high level of summer usage. Alteration to the roof forms to provide pitched roofs would be more consistent with other riverside buildings and local character. The existing flat roof currently accommodates solar heating panels, and any new roof form would need to provide the same function.



Farm Animals



Railway Bridge



Historic Bridge



Community Art

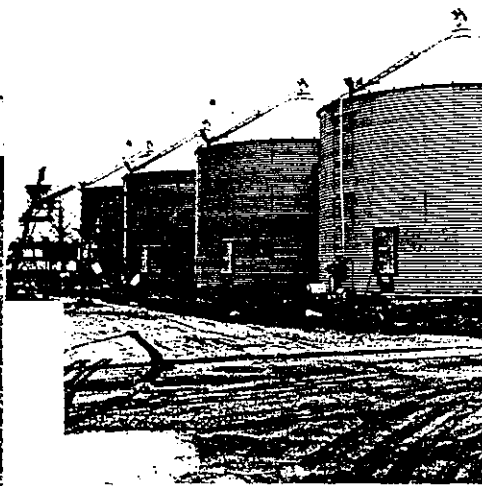

Silos

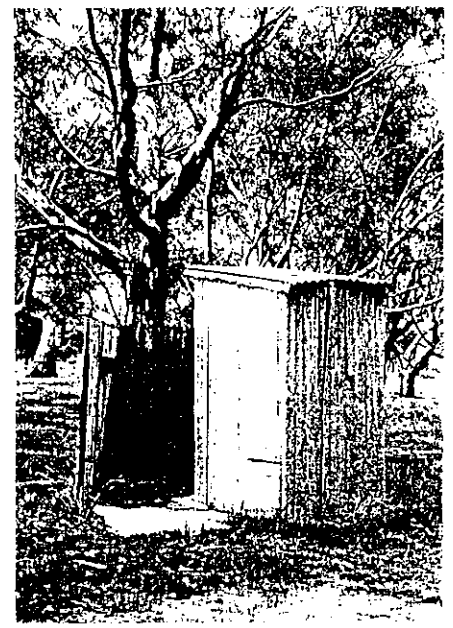

Outdoor Toilet



Farm Machinery



Entry Tyres

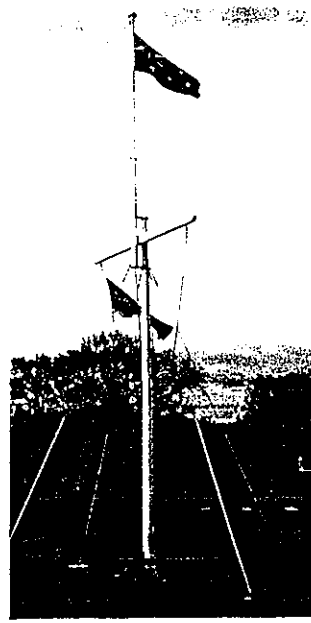

Flagpole

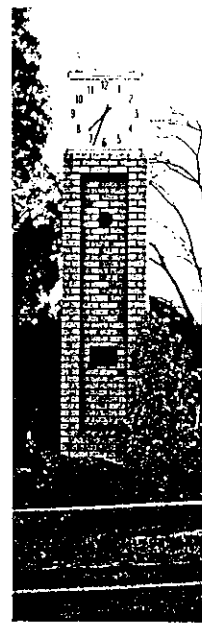

Civic Clock Tower



Historic Water Trough

MARK MCWHA
LANDSCAPE
ARCHITECT
27398 SMITH ST
COLLINGWOOD 3066
PH 416 1755 FX 416 0508

LANDSCAPE ELEMENTS
WINCHELSEA TOWNSCAPE STUDY

Figure No. 5



'Residential setback' front yard as forecourt to caravan park.

Landmark peppercorn tree

'Historic' bluestone shop, with distinctive verandah + overhanging commercial signage.

Brick Pub with 30's upgrade.

Consistent sense of scale to traditional 'period' group of buildings.

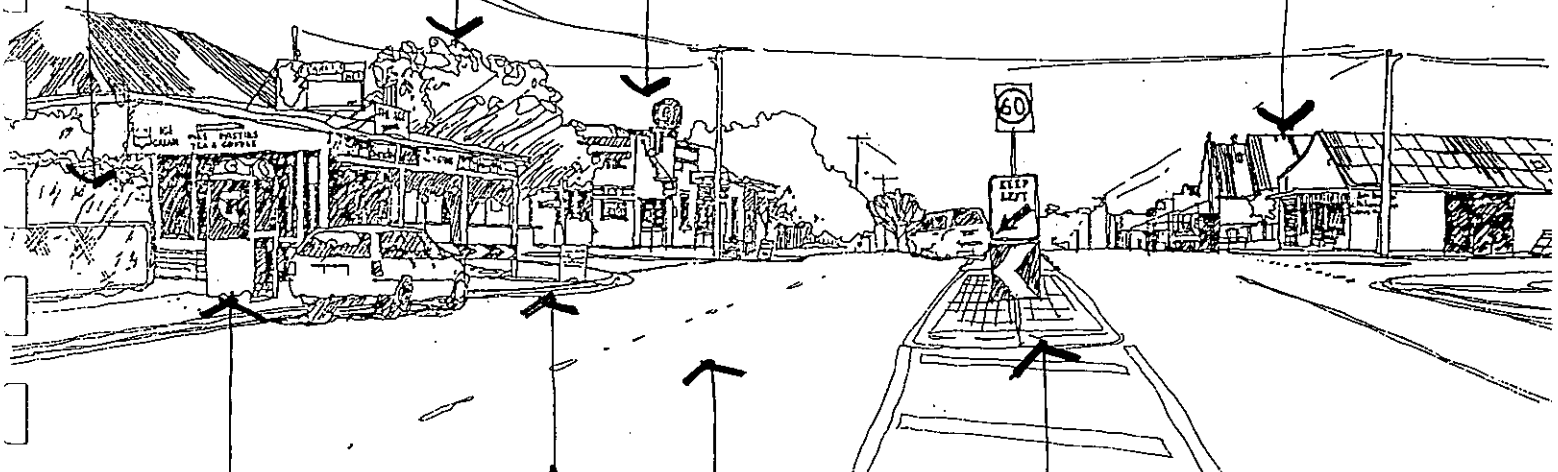

Recent kerb extensions at intersection.

Modular paving + VicRoads signage

Phone box, mail box behind 'Sandwich' board signs.

Wide asphalt expanse, and crest of road provides a distinctive setting for this group of traditional 'country town' buildings, with a great sense of character.

MARK MCWHA
LANDSCAPE ARCHITECT

2/398 SMITH ST
COLLINGWOOD 3066
PH 416 1755 FX 416 0508

WILLIS STREET LOOKING SOUTH-WEST
WINCHELSEA TOWNSCAPE STUDY



Figure No. 6

Crassy 'rustic' edge
with open post + wire
fence - reinforces
'country town' character.

Period 'milk bar' shop
with characteristic
ad hoc commercial
signage.

Barwon River
vegetation as visual
backdrop.

'Historic'
Globe Theatre

typical corrugated
iron roofscapes

Distinctive verandah
streetscape.

Traffic
splitter island.

Wide expanse of
road asphalt.

Road veers down to
left without focus or
sense of arrival.

Residential garden.
provides staggered
streetscape setback.

MARK MCWHA
LANDSCAPE
ARCHITECT

2/398 SMITH ST
COLLINGWOOD 3066
PH 416 1755 FX 416 0508

WILLIS STREET LOOKING SOUTH-WEST
TOWARD GLOBE THEATRE
WINCHELSEA TOWNSCAPE STUDY



Figure No. 7

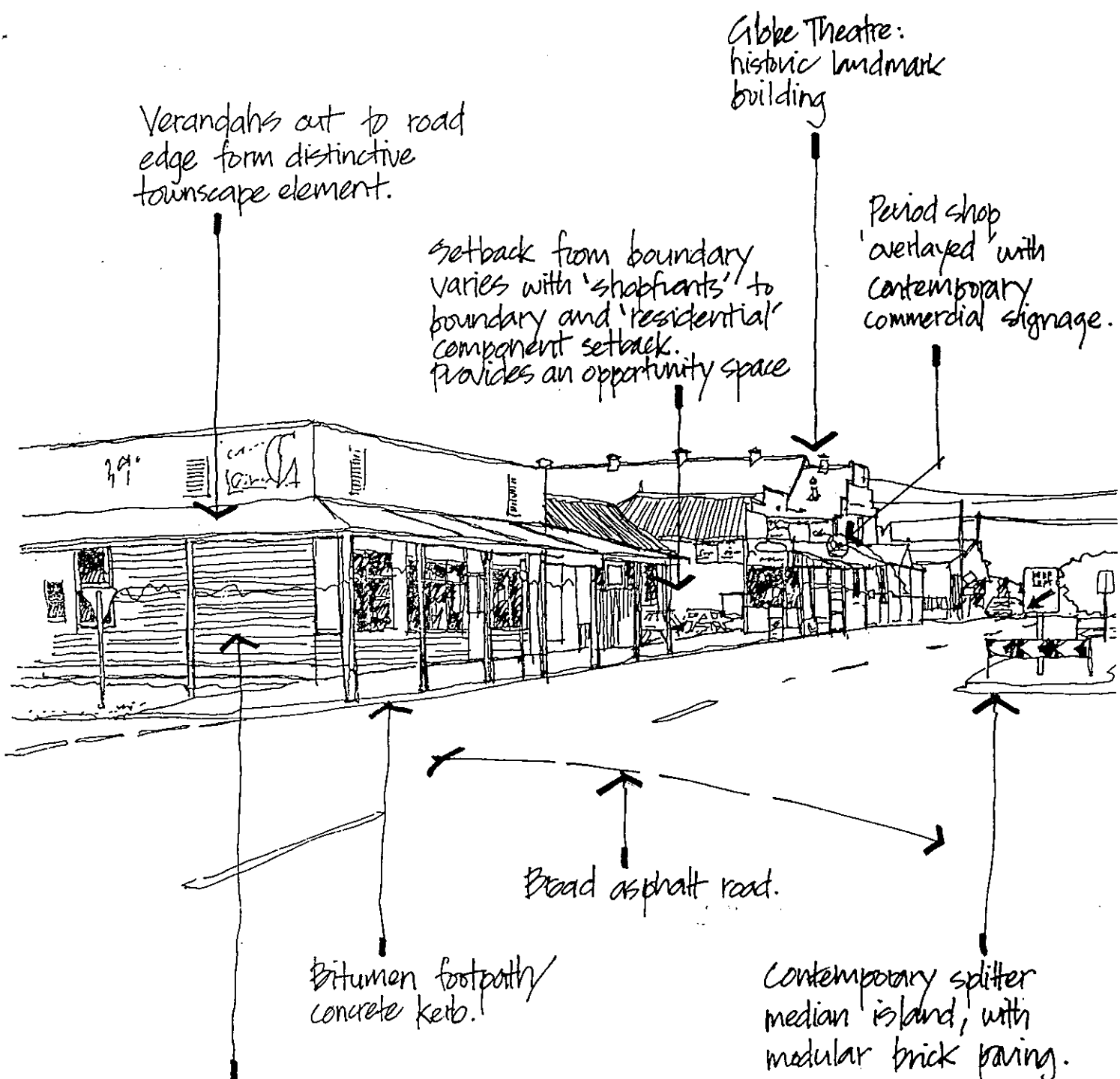

Verandahs out to road edge form distinctive townscape element.

Globe Theatre: historic landmark building

Period shop 'overlayed' with contemporary commercial signage.

setback from boundary varies with 'shopfronts' to boundary and 'residential' component setback. Provides an opportunity space

Broad asphalt road.

Bitumen footpath/ concrete kerb.

Contemporary splitter median island, with modular brick paving.

'Historic' streetscape character, with consistent sense of scale, single storey, predominantly timber buildings, with traditional corrugated iron roofs.

MARK MCWHA
 LANDSCAPE ARCHITECT
 2/398 SMITH ST
 COLLINGWOOD 3066
 PH 416 1755 FX 416 0508

WILLIS STREET BETWEEN HARDING
 AND AUSTIN STREETS LOOKING NORTH-EAST
 WINCHELSEA TOWNSCAPE STUDY



Figure No. 8

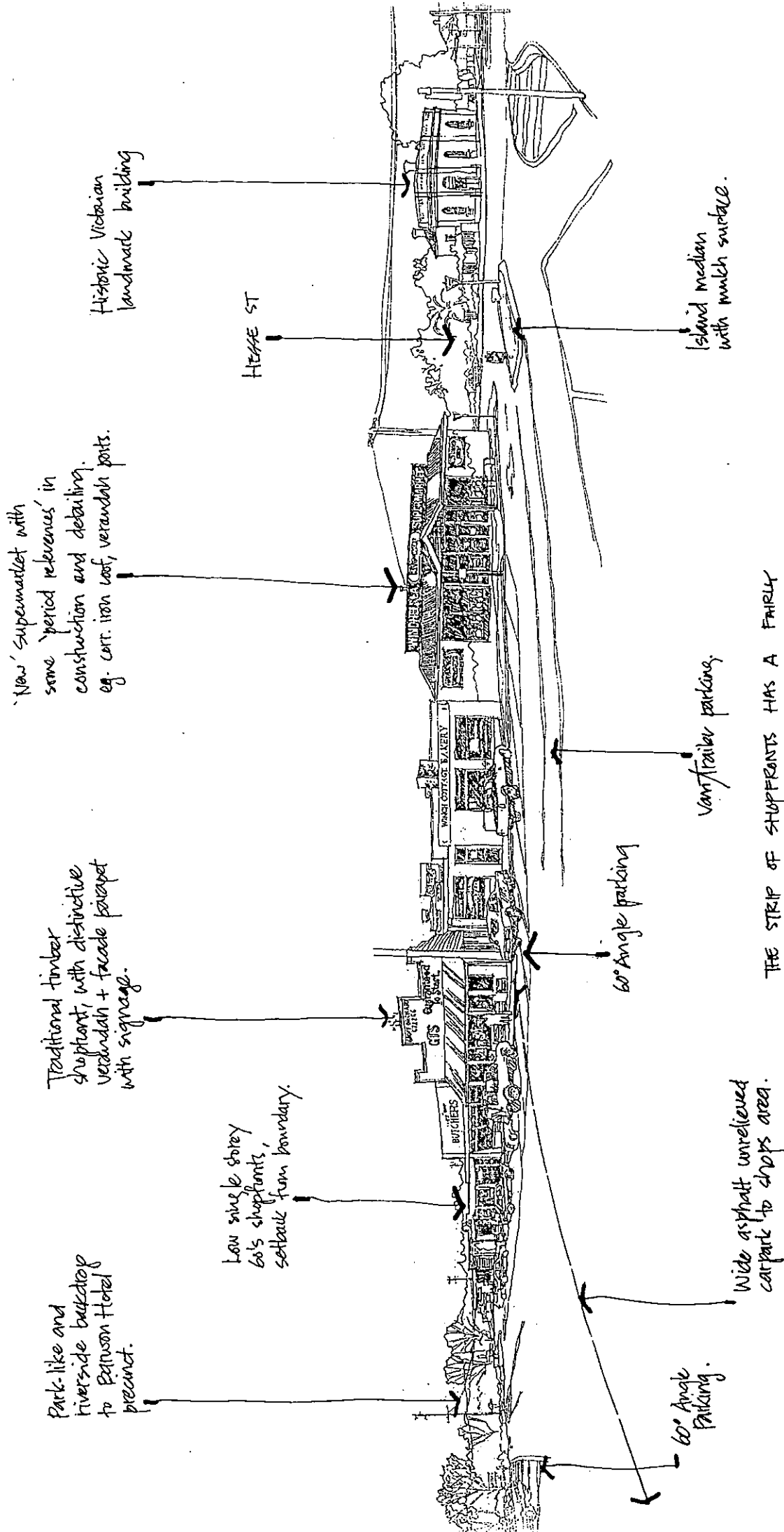

New supermarket with some period references in construction and detailing. eg. corr. iron roof, verandah posts.

Traditional timber shopfront, with distinctive verandah + facade parapet with signage.

Park-like and riverside backdrop to Paterson Hotel precinct.

Low single storey 60's shopfronts, setback from boundary.

Historic Victorian landmark building

HESSE ST

Island median with much signage.

60° Angle parking

Van/trailer parking

Wide asphalt unrelieved carpark to shops area.

60° Angle Parking.

THE STRIP OF SHOPFRONTS HAS A FAIRLY CONSISTANT VISUAL SCALE AND CHARACTER, WITH RELATIVELY NARROW FRONTAGES AND SINGLE STOREY CONSTRUCTION.

MAIN STREET SHOPS BETWEEN PALMER AND HESSE STREETS LOOKING SOUTH-EAST WINCHELSEA TOWNSCAPE STUDY

MARK MCWHIA
LANDSCAPE
ARCHITECT
2/398 SMITH ST
COLLINGWOOD 3066
PH 416 0755 FX 416 0508

Figure No. 9

Milk Bar - store well renovated Victorian shop-front with bull-nose verandah out to road edge.

Gaps in streetscape with setbacks to 'residential' allotments - provides variety, and does not seem to interrupt the continuity or streetscape integrity.

View to Barwon R. and hills beyond town.

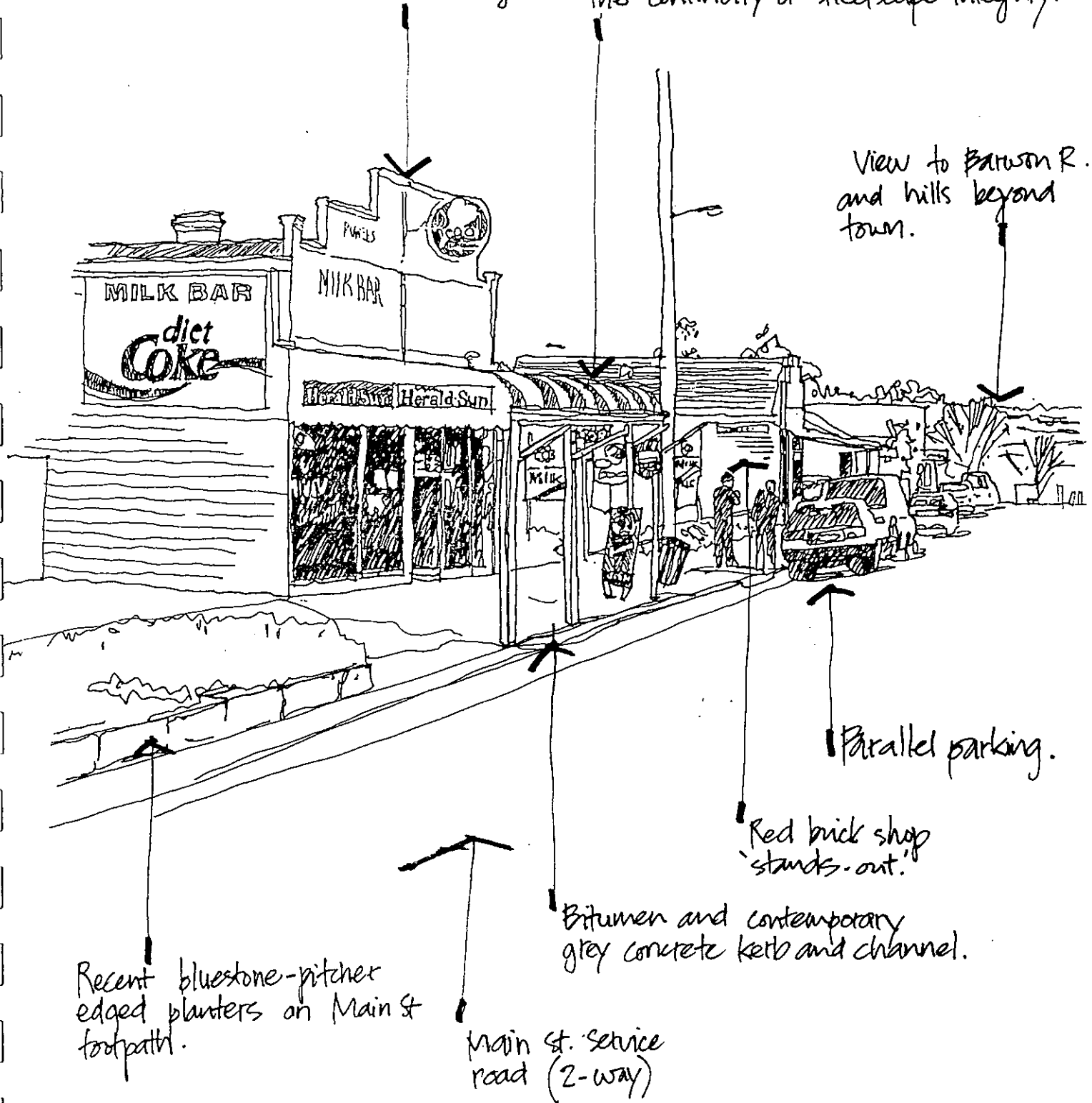

Recent bluestone-pitched edged planters on Main St footpath.

Main St. Service road (2-way)

Red brick shop 'stands-out.'

Bitumen and contemporary grey concrete kerb and channel.

Parallel parking.

MARK MCWHA
LANDSCAPE
ARCHITECT

2/398 SMITH ST
COLLINGWOOD 3066
PH 416 1755 FX 416 0508

MAIN STREET LOOKING NORTH-EAST
WINCHELSEA TOWNSCAPE STUDY



Figure No. 10



Public Toilets



Picnic Shelter

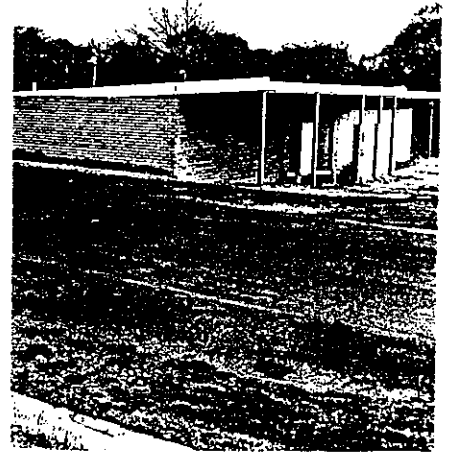

Public Pool Pavilion

MARK McWHA
LANDSCAPE
ARCHITECT
2/398 SMITH ST
COLLINGWOOD 3066
PH 416 1755 FX 416 0508

CIVIC STRUCTURES
WINCHELSEA TOWNSCAPE STUDY

Figure No. 11



2.7 STREETScape FURNITURE AND SIGNAGE

Like many local municipal areas, the street furniture and signage in Winchelsea has been installed over a long period of time, and is in a varied state of repair. Figures 12 and 13 provide an indication of some of these elements.

The introduction of recycled plastic benches in recent years was based on environmental grounds. Their continued use seems appropriate in open space areas, but the benches lack a sense of civic quality for the town's civic and retail precincts.

The 'Surfcoast' shire theme, graphics and suite of signage is of high quality and strong identity. The 'surf' context is a bit remote in this rural location. It is important for Winchelsea to both retain the shire 'corporate' identity, and to establish a sense of unique identity.

It will be important for the town to adopt a unifying and consistent suite of street furniture elements.

2.8 GROUND AND PAVING ELEMENTS

Winchelsea is a town with traditional wide streets.

The wide gravel roadside verges, sometimes grassed between the asphalt and gutter, provide a distinctive character - as do the many open swale drains and bluestone pitcher channels.

The traditional materials - asphalt, local gravel, bluestone pitchers, and plain grey concrete, all sit comfortably in the streetscape here. More recent additions, such as the 'red-pink' modular pressed concrete paving infill in highway splitter island bays, sit less comfortably in the streetscape. Figure 14 shows a range of typical streetscape paving elements.

2.9 TRADITIONAL AND NATIVE THEME PLANTING

Bold copses of Sugar Gums (*Eucalyptus cladocaylx*) dramatically frame the western entry to Winchelsea whilst remnant Drooping Sheoak (*Allocasuarina verticillata*) and isolated group plantings of Southern Mahogany Gum (*Eucalyptus botrioides*) announce the eastern entry. Both groups of native trees could be strengthened to provide strong town gateway planting themes.

The main roads of the town have been planted predominantly with traditional avenue theme trees such as English Elms (*Ulmus procera*), Ash (*Fraxinus excelsior*), and Peppercorns (*Schinus molle*), most of which are mature, with many now in decline. More recently, native plantings

have occurred along the Main Street median and appear somewhat out of character with the established town centre avenue theme trees.

The banks of the Barwon River are dominated by copses of River Red Gums (*Eucalyptus camaldulensis*) and associated indigenous riparian vegetation, together with Poplar suckers, Pines and Willows which occur around the town centre and have been identified for gradual removal. Many native trees and shrubs have recently been planted on the north-west bank in between Barkly Street and the Railway Bridge.

A traditional Monterey cypress and Radiata pine hedgerow has been established around the eastern football oval forming a bold 'windbreak' image that is typical of the Western District area.

Figures 15 and 16 show typical traditional theme trees, and native and indigenous theme trees. The following table lists indigenous trees and shrubs found commonly in the study area.

INDIGENOUS RIVER RED GUM ASSOCIATION FOR WINCHELSEA

Botanical Name

Common Name

TREES

<i>Acacia dealbata</i>	Silver Wattle
<i>Acacia implexa</i>	Lightwood
<i>Acacia mearnsii</i>	Black Wattle
<i>Acacia melanoxylon</i>	Blackwood
<i>Acacia pycnantha</i>	Golden Wattle
<i>Allocasuarina littoralis</i>	Black Sheoak
<i>Allocasuarina verticillata</i>	Drooping Sheoak
<i>Eucalyptus camaldulensis</i>	River Red Gum
<i>Eucalyptus obliqua</i>	Messmate
<i>Eucalyptus ovata</i>	Swamp Gum
<i>Eucalyptus viminalis</i>	Manna Gum

SHRUBS AND TUSSOCKS

<i>Acacia acinacea</i>	Gold Dust Wattle
<i>Banksia marginata</i>	Silver Banksia
<i>Bursaria spinosa</i> var. <i>spinosa</i>	Sweet Bursaria
<i>Cassinia aculeata</i>	Common Cassinia
<i>Correa alba</i>	White Correa
<i>Correa glabra</i>	Rock Correa
<i>Danthonia caespitosa</i>	Wallaby Grass
<i>Dianella revoluta</i> var. <i>revoluta</i>	Black-anther Flax-lily
<i>Dodonea viscosa</i>	Giant Hop-Bush
<i>Exocarpus cupressiformis</i>	Cherry Ballart
<i>Goodenia ovata</i>	Goodenia
<i>Helichrysum dendroideum</i>	Shrub Everlasting
<i>Hymenanthera dentata</i>	Tree Violet
<i>Lomandra longifolia</i>	Long-leaf Mat Rush
<i>Olearia ramulosa</i> var. <i>ramulosa</i>	Twiggy Daisy Bush
<i>Poa labillardieri</i>	Common Tussock Grass
<i>Stipa</i> spp.	Spear Grass
<i>Themeda triandra</i>	Kangaroo Grass

RIPARIAN SHRUBS AND AQUATICS

<i>Callistemon paludosus</i>	River Bottle Brush
<i>Calotis anthemoides</i>	Burr Daisy
<i>Carex tereticaulis</i>	Tall Sedge
<i>Cotula coronopifolia</i>	Water Buttons
<i>Eleocharis sphacelata</i>	Tall Spike-rush
<i>Juncus</i> spp.	Rushes
<i>Leptospermum lanigerum</i>	Woody Tea-Tree
<i>Leptospermum obovatum</i>	River Tea-tree
<i>Lomandra longifolia</i>	Long-leaf Mat-Rush
<i>Marsilea drummondii</i>	Common Nardoo
<i>Myriophyllum muelleri</i>	Hooded Milfoil
<i>Phragmites australis</i>	Common Reed
<i>Poa labillardieri</i>	Common Tussock Grass
<i>Triglochin procera</i>	Water Ribbons



Litter Bins



Seats



Seat



Treated Pine Barrier



Bluestone Planter

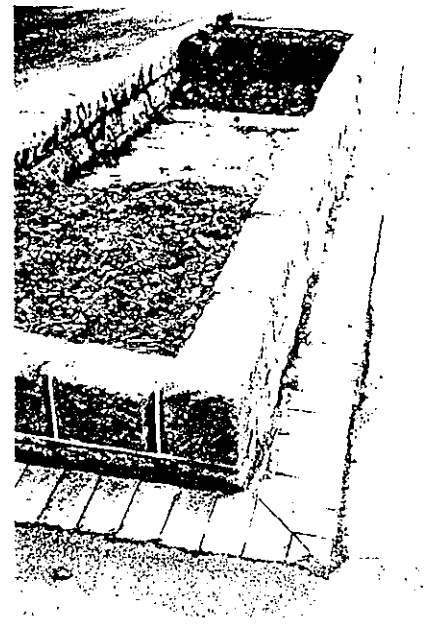

Bluestone Planter



Information Shelter

MARK MCWHA
LANDSCAPE
ARCHITECT
27398 SMITH ST
COLLINGWOOD 3066
PH 416 1755 FX 416 0508

STREETSCAPE FURNITURE
WINCHELSEA TOWNSCAPE STUDY

Figure No. 12





Reserve Sign



Community Art



Entry Sign



Retail Signage

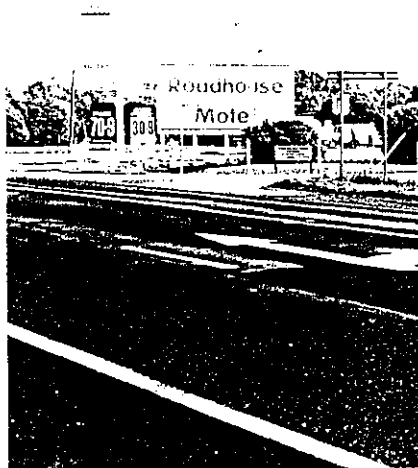

Roadhouse Sign



Industrial Signage

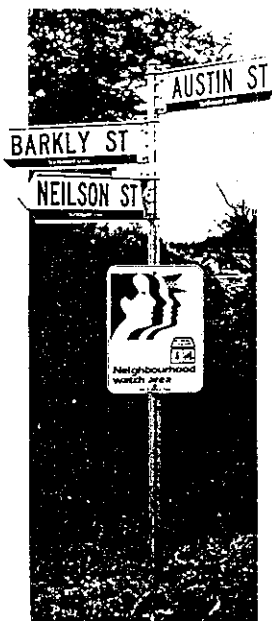

Street Sign



Bike Path Signage



Hotel Sign

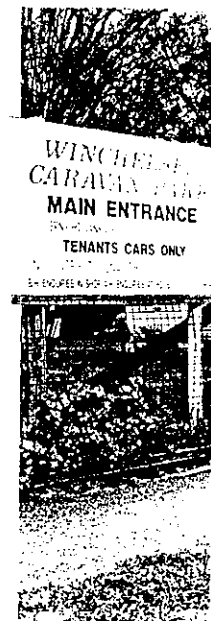

Caravan Park Sign

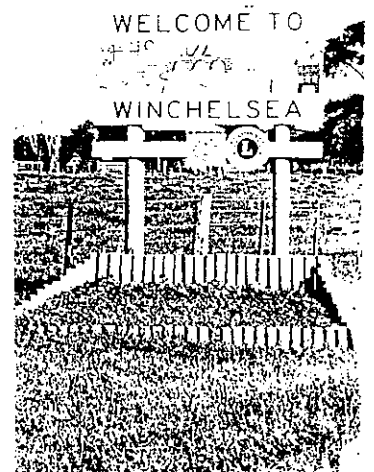

Entry Sign

MARK MCWHA
LANDSCAPE
ARCHITECT
27398 SMITH ST
COLLINGWOOD 3066
PH 416 1755 FX 416 0508

SIGNAGE
WINCHELSEA TOWNSCAPE STUDY





Kerb Extension



Traffic Island



Splitter Island



Gravel Road

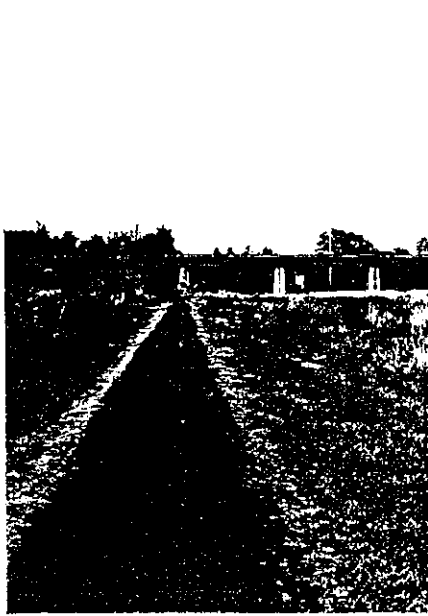

Bitumen Path



Concrete Paving

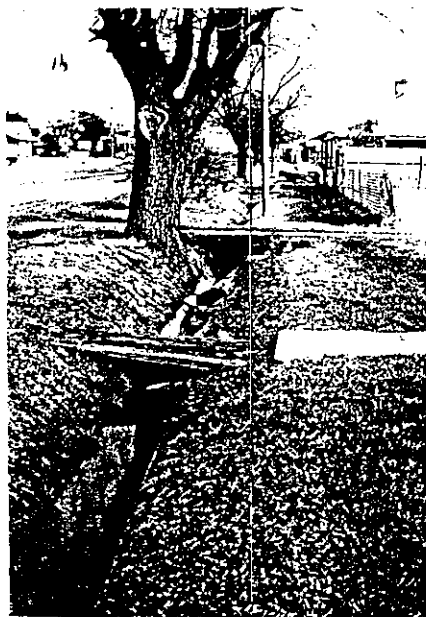

Concrete Open Channel



Concrete Kerb

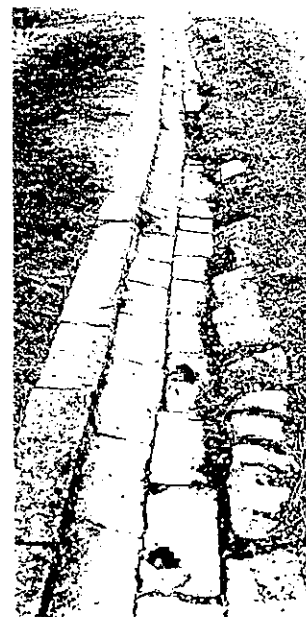

Bluestone Gutter

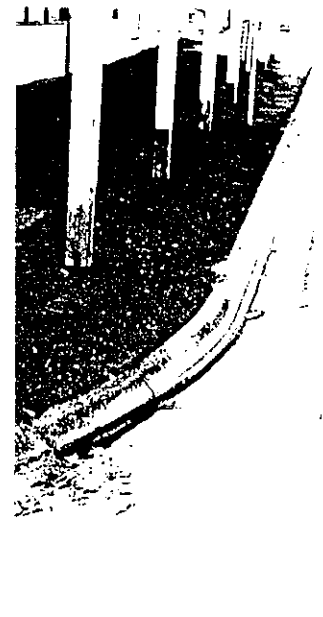

Bitumen Paving

MARK McWHIA
LANDSCAPE
ARCHITECT
2/398 SMITH ST
COLLINGWOOD 3066
PH 416 1755 FX 416 0508

GROUND ELEMENTS
WINCHELSEA TOWNSCAPE STUDY

Figure No. 14





Canary Island Pines



Pines

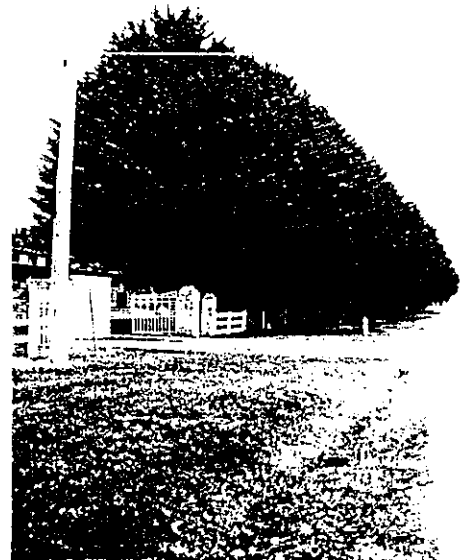

Cypress Hedgerow



Peppercorn Tree



Bhutan Cypress



Canary Island Palm



Poplars



Ash Avenue



English Elms

MARK MCWHA
LANDSCAPE
ARCHITECT

2/398 SMITH ST
COLLINGWOOD 3056
PH 416 1755 FX 416 0508

TRADITIONAL THEME TREES
WINCHELSEA TOWNSCAPE STUDY

Figure No. 15





Sugar Gums



Recent Plantings

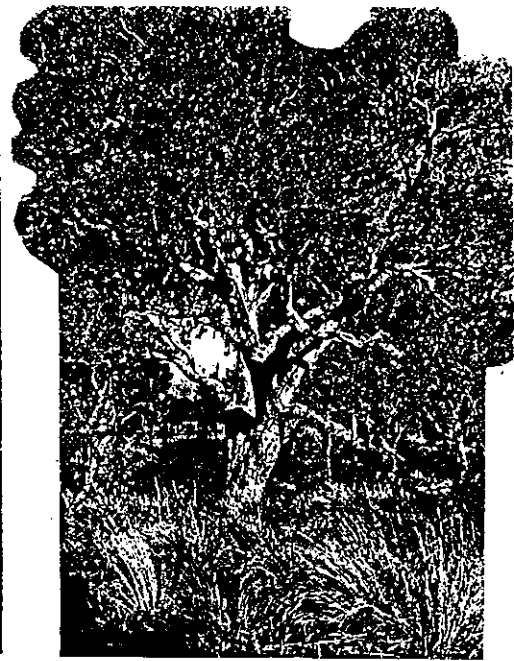

River Red Gum



River Red Gum

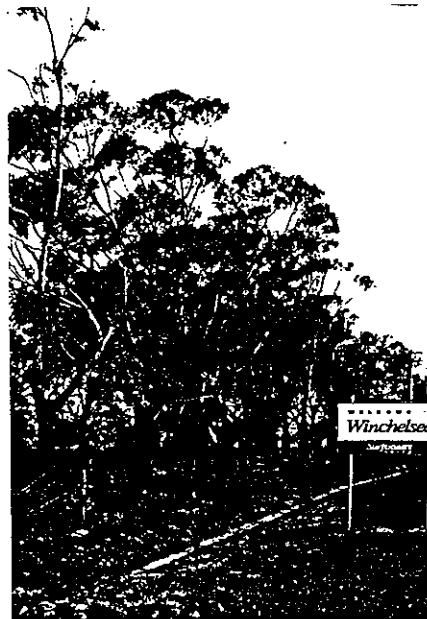

Mahogany Gums

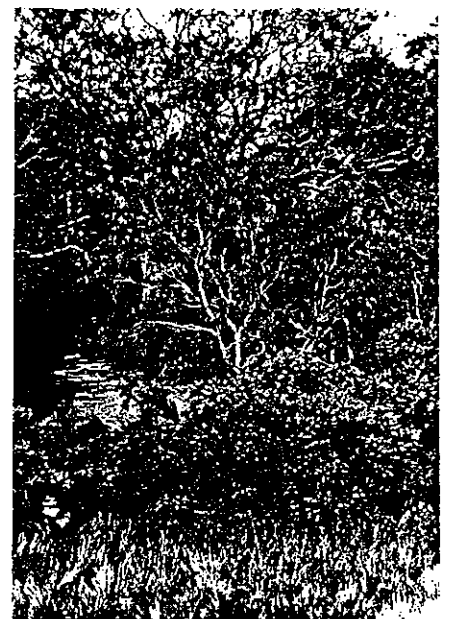

Riparian Vegetation (including Gorse)

MARK MCWHA
LANDSCAPE
ARCHITECT
2/398 SMITH ST
COLLINGWOOD 3066
PH 416 1755 FX 416 0508

NATIVE THEME TREES
WINCHELSEA TOWNSCAPE STUDY

Figure No. 16



3.0 TOWNSCAPE MASTERPLAN

This section of the report deals with recommendations for improving the townscape character. The ideas and actions identified have been reviewed with the Community Reference and Steering Group and have received general support. The proposals are shown on Figure 17, the Broad Townscape Concept Plan, and figures 18 and 19, the Barwon River and Town Centre Action Plans.

3.1 BROAD TOWNSCAPE OPPORTUNITIES

The following proposals have been identified as high priority objectives:

- (1) Major town gateways to the east and west are to be established with strong native/indigenous planting themes; i.e. groups of Drooping Sheoak (*Allocasuarina verticillata*) to the eastern entry, and tight coppiced plantings of Sugar Gums (*Eucalyptus cladocaylx*) to the west. These later will assist to screen the light industrial areas to the west, and reduce their visual impact.
- (2) Strengthen and continue the former avenue of exotic theme trees along Willis/Main Streets (Princes Highway) as a major traditional exotic avenue to enhance 'heritage' qualities of townscape. An appropriate tree would be red oak (*Quercus rubra*) which is a large, open tree which can be pruned around power lines, which is available as an advanced tree.

All secondary town entries are to be planted with single species avenue theme trees:

Inverleigh Road:	Scarlet Oak <i>Quercus coccinia</i> A traditional exotic tree to lead out to historic Barwon Park.
Bennett Street:	Chinese Elm <i>Ulmus parvifolia</i> A reliable traditional spreading tree to provide a memorial avenue up to the memorial eastern oval gates.
Barwon Terrace:	Flowering Gums <i>Eucalyptus ficifolia</i> A traditional, formal and native tree adjacent to the river environment.
Hesse Street:	Apple Myrtle <i>Angophora costata</i>

Cressy Road: Apple Myrtle *Angophora costata*
A striking gum-like tree which can be pruned around power lines without subsequent epicormic growth.

Deans Marsh Road: Dwarf Snow Gum *Eucalyptus pauciflora 'Nana'*
A smaller spreading eucalypt, where it is not important to respond to the historic town character.

(3) Remove weeds including *Pinus radiata*, Poplar suckers and enhance the indigenous riparian vegetation of the Barwon River. Develop opportunities for future river edge walks with boardwalk viewing decks to the north and south of the town centre.

(4) Encourage native and indigenous theme plantings to public reserves, including Winchelsea Common, the sewerage treatment reserve, Barwon Park residential reserve and Guye Reserve.

(5) Develop a continuous multi-purpose path to link Barwon Park Estate through the town centre to the primary school and beyond. Provide for a low flow ford crossing or a future footbridge link across the Barwon River.

An improved pedestrian crossing at Hesse Street on the Princes Highway has been nominated for better pedestrian/bicycle crossing. The multi purpose path shall provide a safe and direct link for school children, pedestrians and cyclists.

(6) An historic town walk through the town centre has been identified focusing on such features as the former Shire Hall, the Barwon Hotel, the churches, the Memorial Grandstand at the eastern oval, the Winchelsea Hotel, and Willis Street shops. A secondary town walk is also proposed including 'town edge' features such as Winchelsea Railway Station, old stone cottages, and St. John's Church. Both walks could have separate information brochures locating the main features with supporting explanatory text. (These could even be available in the form of tourist souvenirs, such as tea-towels or posters). The route should be identified with simple markers - for example, bluestone sets, with engraved numbers, set into the pavement.

3.2 BARWON RIVER AREA

The Barwon River parkland provides Winchelsea with a valuable asset that should be enhanced and further developed as the town 'common' gardens. The necessary tasks for consideration are, as follows:
(Refer to Figure 18).

(1) Guye Reserve Side:

Implement a long term program to remove all weeds including Poplars and Pinus radiata. Replace with indigenous riparian and river-side vegetation. Retain and protect existing exotic specimen trees, such as the Canary Island Pines and Araucaria. This area is intended as a natural indigenous riverside area.

Provide a pedestrian link along the top of the ridge to Guye Reserve, including a possible timber 'lookout' viewing deck, to view back to the river and the historic bluestone bridge. (Refer to Figure 22).

(2) Barwon Hotel Side:

Rationalise car parking in front of Barwon Hotel to reduce scale of existing gravel area. Implement more formal parking bays and designated bus parking areas to improve access and circulation. (Refer to Figure 20).

Enlarge 'Roundabout' to accommodate a 'picnic gazebo' rotunda and ring of theme trees (Lemon Scented Gums) as a civic focus for the Shopping Centre. (Refer to Figure 20). Relocate cannon and farm machinery to selected positions. Proposed picnic shelter to be located towards river's edge as shown in Figure 19. Improve pedestrian circulation to riverside picnic area providing a connection under bridges to the Old Shire Hall and North-west bank.

Gradually as large mature Poplars along Highway embankment decline and die, remove and replace them with indigenous theme trees such as River Red Gums. Develop a forward planting program so that major gaps do not occur. The existing large River Red Gum to be protected, and the visually obtrusive signs nailed to the trunk should be removed and avoided in the future.

New toilet facilities will service the picnic area; and the retail area on this side of the river. It should be carefully located to avoid impeding views into the open space or of the shops, as suggested on the plan.

(3) Pool/Picnic Reserve Side:

Improve access and circulation. Develop a multi-purpose path that connects down from the highway bridge onto the existing shared footway along the riverbank. Restrict vehicle access to the western entry only. (This could be undertaken on a trial basis). Improve pedestrian links from the existing public toilets facility to the picnic area also providing a 1 in 20 disabled access path to the rivers edge. (Refer to Figure 19).

Remove the mud brick picnic shelter when it is replaced with new proposed timber picnic structures in selected locations (Refer to Figure 21). Rationalise the surrounding furniture, barbecue facilities and play equipment.

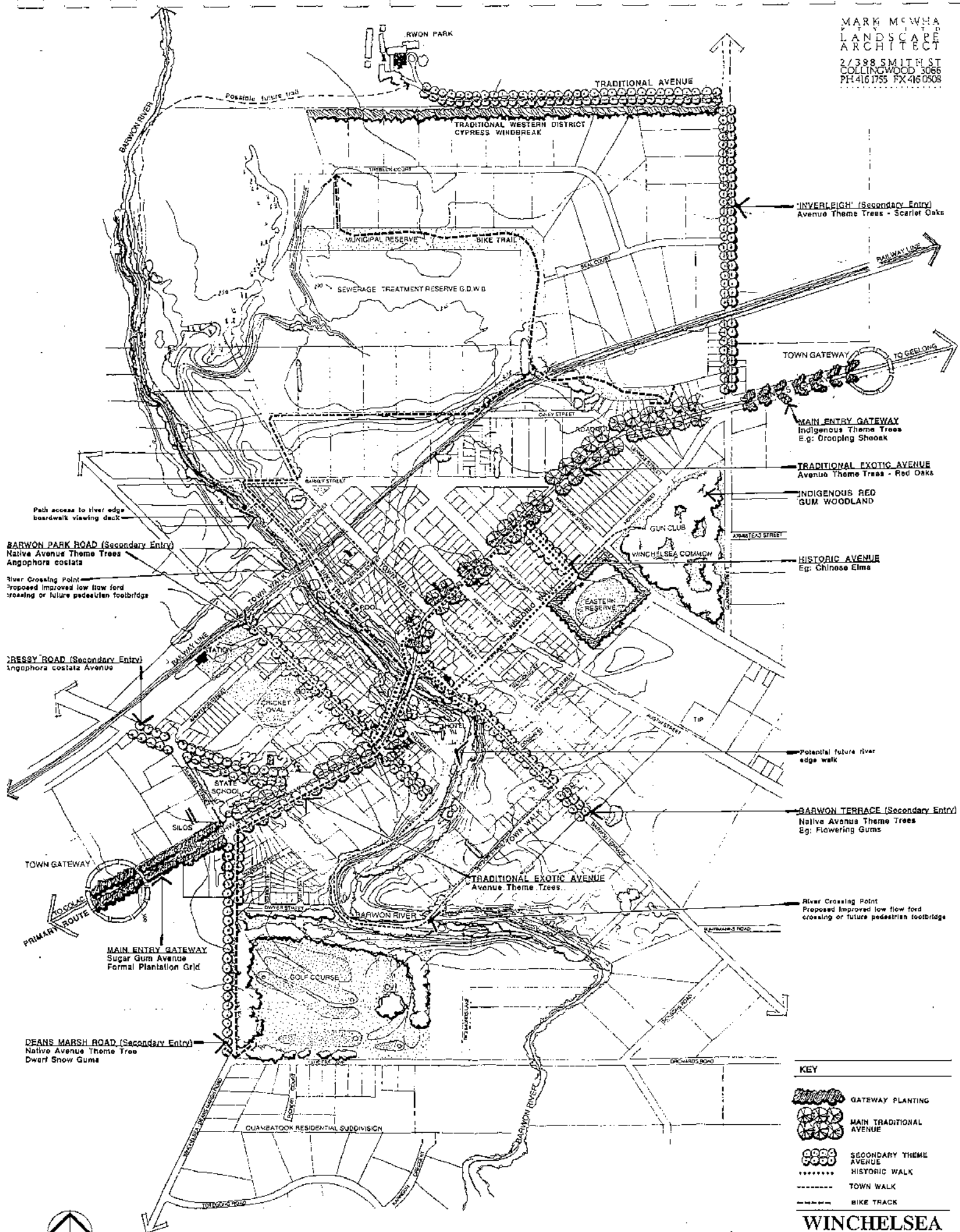

KEY

	GATEWAY PLANTING
	MAIN TRADITIONAL AVENUE
	SECONDARY THEME AVENUE
	HISTORIC WALK
	TOWN WALK
	BIKE TRACK

**WINCHELSEA
TOWNSCAPE
STUDY**

BROAD TOWNSCAPE CONCEPT PLAN Figure No. 17



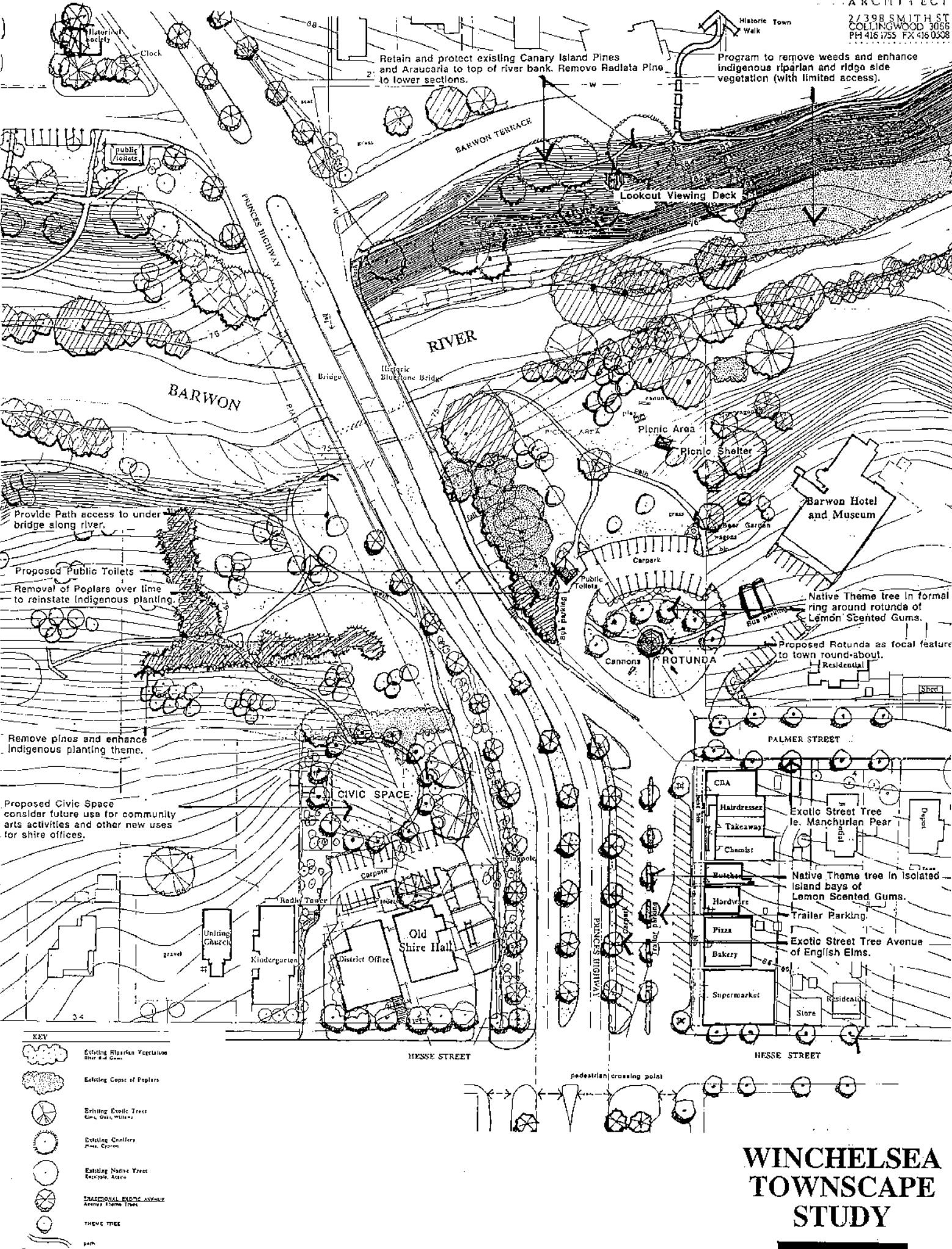

TOWN CENTRE ACTION PLAN Figure No. 19

WINCHELSEA TOWNSCAPE STUDY



Remove cyclone fencing to barbecue area adjacent to pool and also remove shelter structure above barbecue. Upgrade area with new picnic tables and native theme trees plantings i.e. Blackwood (*Acacia melanoxylon*), Silver Wattle (*Acacia dealbata*), River Red Gum (*Eucalyptus camaldulensis*) Yellow box (*Eucalyptus melliodora*), Drooping She-oak (*Allocasuarina verticillata*) etc.

Upgrade public pool facilities including renovation of existing pool pavilion. Provide carparking west of pavilion with surrounding native screen planting to embankment.

(4) Bluestone Shire Hall Side:

Removal of the former out-buildings and storage areas behind the former Shire Hall has provided a large open 'opportunity' space with good carparking access. This area would be suitable for a civic use, such as a community art sculpture park or other similar use. The use does not need to be defined immediately, but it will be important to improve the pedestrian/bicycle access and circulation, providing connections to the bluestone Shire Hall area, under the bridge to the south-west bank and across the Barwon River to the north-east bank.

Remove existing pines and enhance indigenous planting theme in this area.

3.3 TOWN CENTRE

Overall, the town centre has many aesthetic qualities that should be maintained and enhanced. The following objectives have been identified as key issues: (Refer to Figure 19).

(1) Highway Avenue:

Introduce a significant avenue of traditional exotic themes trees - Red Oaks (*Quercus rubra*) along Willis/Main Streets (Princes Highway) to enhance the traditional heritage character of the townscape. Remove recent native plantings in the median to the west of the town centre and continue traditional avenue planting theme.

(2) Main Street Shops (in between Hesse and Palmer Streets):

Rationalise the carpark area. Maintain angle parking with kerb extensions at ends. Define trailer parking area with introduction of island bays and native theme trees (Lemon Scented Gums). Maintain existing 'off-ramp' access from Princes Highway with new traffic signage to direct/slow motorists.

Improved carparking/busparking facilities to the 'roundabout' area in front of the Barwon Hotel as discussed in Section 3.2.

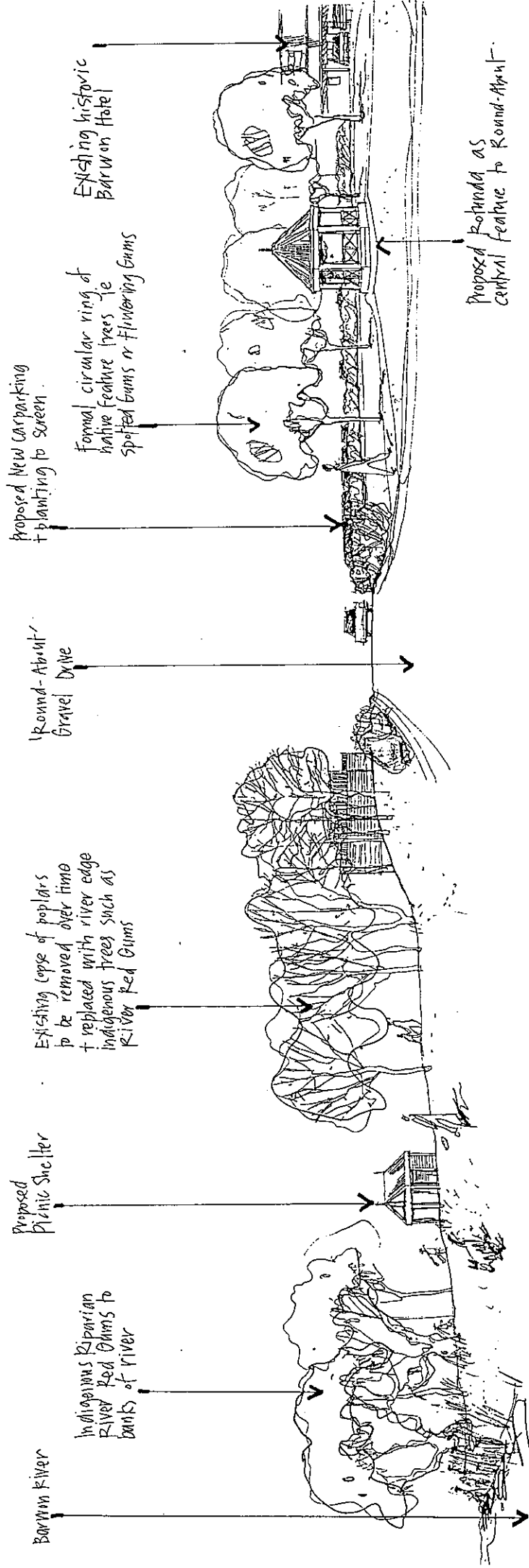

MARK MCSWAHA
 LANDSCAPE
 ARCHITECT
 2/338 SMITH ST
 COLLINGSWOOD VIC 3066
 PH: 4161733 FX: 4160308
 WWW.MARKMCSWAHA.COM.AU

SECTION THROUGH SOUTHBANK PICNIC AREA TO PROPOSED ROTUNDA.
 WINCHELSEA TOWNSCAPE STUDY.

Figure No. 20



A pedestrian/bicycle crossing point on Princes Highway has been nominated on the west side of Hesse Street. Exact details to be determined by traffic engineering strategies.

(3) Historic Bluestone Hall:

This area provides an opportunity to be developed as a town centre civic focal point.

The introduction of a carpark to the rear of the district Shire offices and Old Shire Hall has been proposed. Vehicle access is still maintained to the front of the hall with drop-off facilities, feature garden beds and paved gathering spaces.

The focal Canary Island Palm is to be maintained. A 'civic space' is proposed north of the Shire hall for community activities and an open space link with the river parklands.

(4) Willis Street Shops:

Conserve and protect existing historic streetscape facade. Any structural upgrades or renovations are to be completed in accordance with applicable 'heritage' conservation guidelines.

Rationalise shop signage, street furniture and planting to develop a cohesive streetscape character.

Proposed picnic shelters
with picnic tables + bbq
facilities.

Proposed native copse
planting
Eucalyptus dulensis, *Acacia
melanoxylon*, *A. dealbata*

Disabled Access.

Barwon river +
Bridge



MARK MCWHA
P T Y L T D
LANDSCAPE
ARCHITECT

2/398 SMITH ST
COLLINGWOOD 3066
PH 416 1755 FX 416 0508

SKETCH VIEW OF PROPOSED PICNIC SHELTERS
TO NORTH-WEST BANK.

WINCHELSEA TOWNSCAPE STUDY

Figure No. 21



Significant
River Red Gum
to be protected

Landmark pines (canary island pines and Araucaria)
to be retained + protected at top of ridge
Other pinus radiata to be removed

General tidy up +
removal of weeds
to river edge.
Enhancement of
Indigenous vegetation

Historic Bluestone
Bridge

proposed lookout
viewing timber
deck

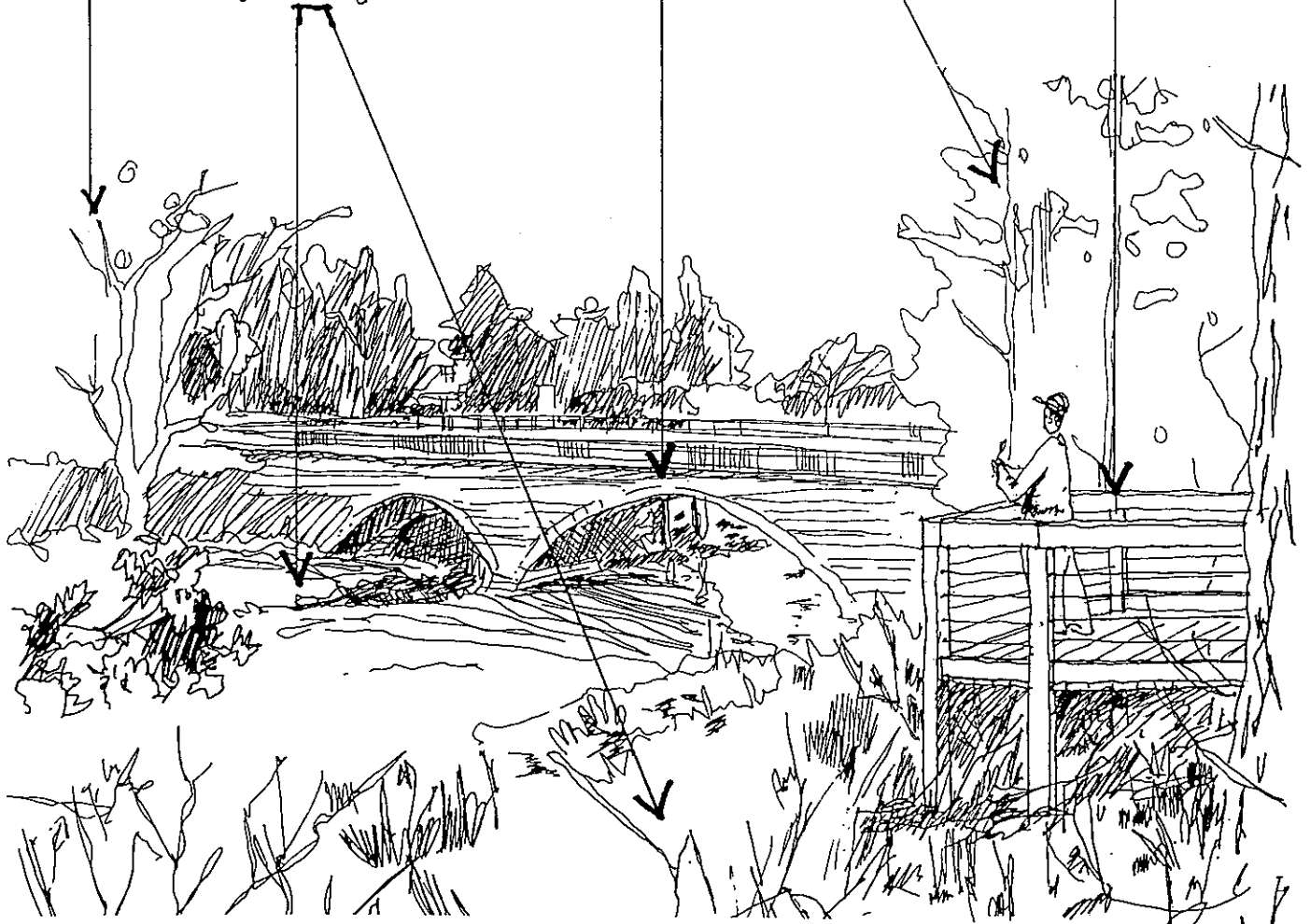

MARK MCWHA
LANDSCAPE
ARCHITECT

2/398 SMITH ST
COLLINGWOOD 3066
PH 416 1755 FX 416 0508

SKETCH VIEW TO NORTH-EAST BANK.

WINCHELSEA TOWNSCAPE STUDY

Figure No. 22



MARK MCWHARD
 LANDSCAPE
 ARCHITECT
 2/398 SMITH ST
 COLLINGWOOD 3066
 PH 416 1755 FX 416 0508

HEAVY DUTY
 'WEATHERBOARD'
 CLADDING.

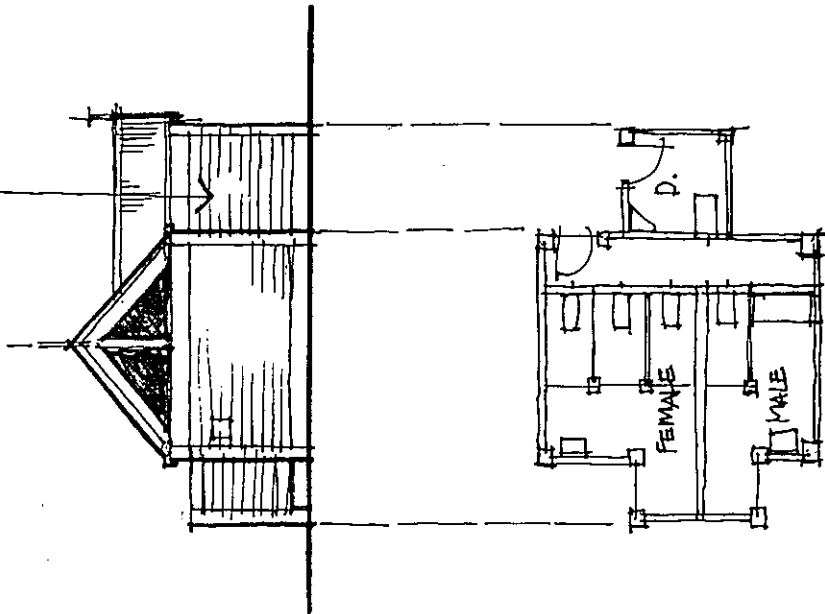

TOILETS

CORRUGATED IRON
 ROOF

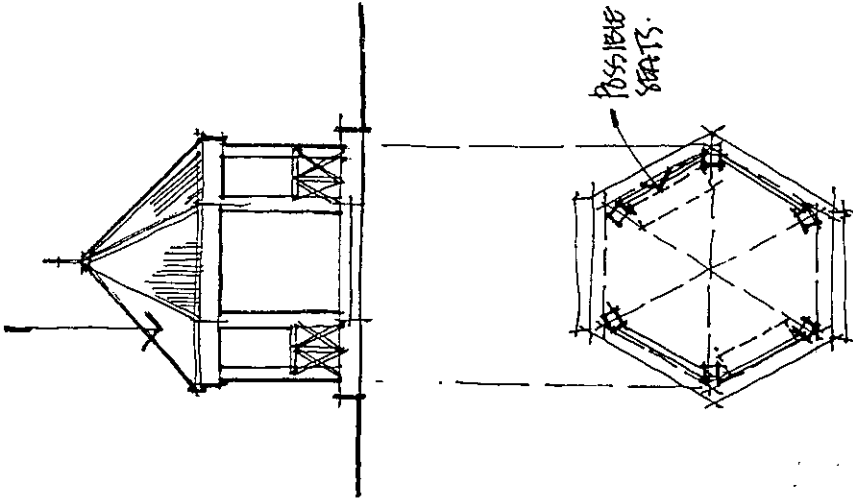

'ROTONDA'

NATURAL TIMBER STRUCTURE:
 FASCIA BEAMS, POSTS ETC.

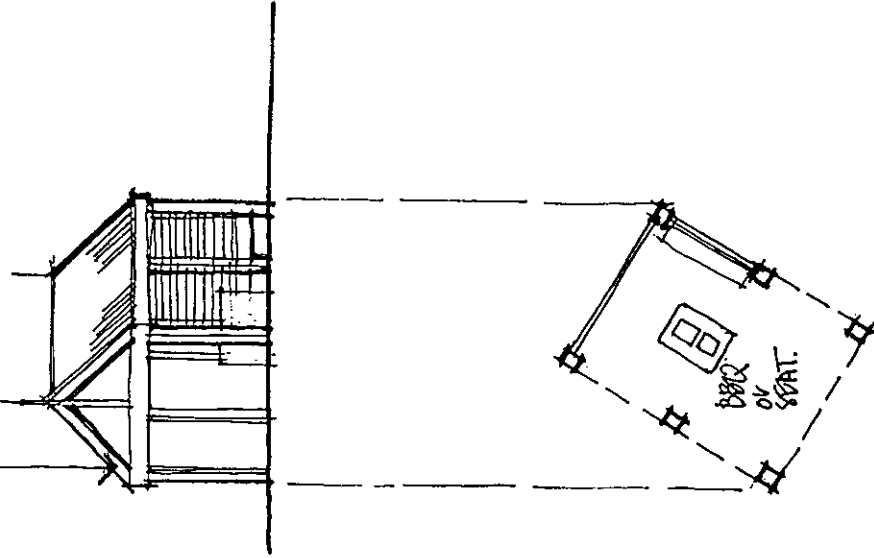

PICNIC SHELTER.

WINCHELSEA
 TOWNSCAPE
 STUDY



4.0 FURNITURE DESIGN GUIDELINES

4.1 SITE FURNITURE

An important component of the visual unification of the streetscape will be the introduction of a consistent suite of well designed street furniture. The proposed elements are shown on figure 24.

The following is an outline of the main items:

Seats:

The preferred seat is the MCC type park bench or a similar detail. This is an elegant durable timber slatted bench with painted mild steel banded support frame.

It was felt that the use of entirely metal seats would appear too 'urban' or 'inner city', and that the combination of timber slat and metal trim would suit both the period character of the town, while fitting into a contemporary context.

A preferred colour for the metal frame would be a neutral dark charcoal colour. Timber should have natural 'oil' finish.

Litter bins:

The litter bin designed to match the above seat is proposed.

Park Bench:

The above seat will fit well into an open space environment. In more 'remote' locations, the already adopted recycled plastic bench would be appropriate; for example, Guye Reserve. Benches currently located in the town centre could be reused for this purpose.

Bollards and Vehicle Barriers:

Special ornamental bollards are not generally required. Where bollards are required to highlight entry paths to open space areas, a simple durable hardwood square post with splayed top is shown, with rebate around top and chambered corners.

Lights:

Special ornamental street lights are not required. It is considered that the existing high level utilitarian street lighting is unobtrusive.

The introduction of a 'period' lamp in front of the former shire Hall would highlight this special area.

4.2 SIGNS

The 'Surfcoast Shire' suite of signage has been adopted for Winchelsea, and this serves well to integrate each of the townships within the Shire.

Where interpretation or location signs are required for areas, such as the Barwon river open space area, these could be detailed with natural timber construction as shown on Figure 24. This would compliment other detailing such as the proposed bollard and picnic shelter designs.

5.0 OPEN SPACE STRUCTURES AND ARCHITECTURAL GUIDELINES

5.1 OPEN SPACE STRUCTURES

There is a need for a number of new small public buildings in the open space areas. The need for a new toilet facility near the retail centre had previously been identified. A 'bandstand' or park rotunda would also provide a focus for the transition space between the river and the shops area. A detail guideline has also been prepared for a new picnic shelter unit, which could be used for the various picnic areas. These are shown on Figure 23.

The detailing of each of the elements has been linked to further visually integrate the open space areas. Each utilises natural timber heavy post construction, with timber cladding (heavy duty weatherboard planks) and natural galvanised corrugated iron roofing with a 40° roof pitch. Suitable timbers include: recycled river red gum; cypress pine; iron bark or other durable eucalypt hard wood.

Pool Buildings:

The existing 'flat' roofed cream brick swimming pool buildings contrast so markedly with their surrounds and other buildings, that an upgrade should be considered. The introduction of corrugated iron pitched roofs with posted verandahs would do much to integrate these structures. The posts and fascia beams could match the detailing of the proposed park structures.

5.2 ARCHITECTURAL STREETScape GUIDELINES

Figure 25, Architectural Streetscape Guidelines, illustrates some of the key issues to consider when upgrading streetscape frontages or when designing new development in Winchelsea.

These are intended as guidelines only, and are not meant to stifle architectural excellence or creativity.

Some of the key points to consider are:

Construction Materials:

The majority of buildings in the town are of painted timber construction, with some brick and early bluestone structures.

Most roofs are pitched corrugated iron - painted and natural weathered galvanised finish.

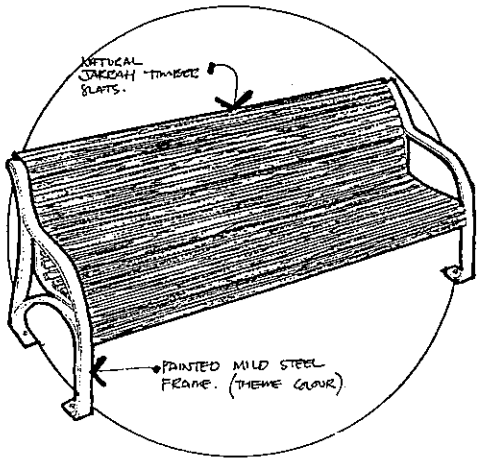

HEAVY DUTY
NATURAL (OILED)
DURABLE HARDWOOD
SLATS.

PAINTED M.S.
SUPPORT FRAME
(CHARCOAL COLOUR)

POLISHED METAL
SPUN, HINGED
LID.

BATTENS TO MATCH
BENCH

MILD STEEL TRIM
(FRAME) TO MATCH
BENCH.

WEATHER
SPLAY TO TOPS.

REBATE.

15mm CHAMFER
TO POST SIDES.

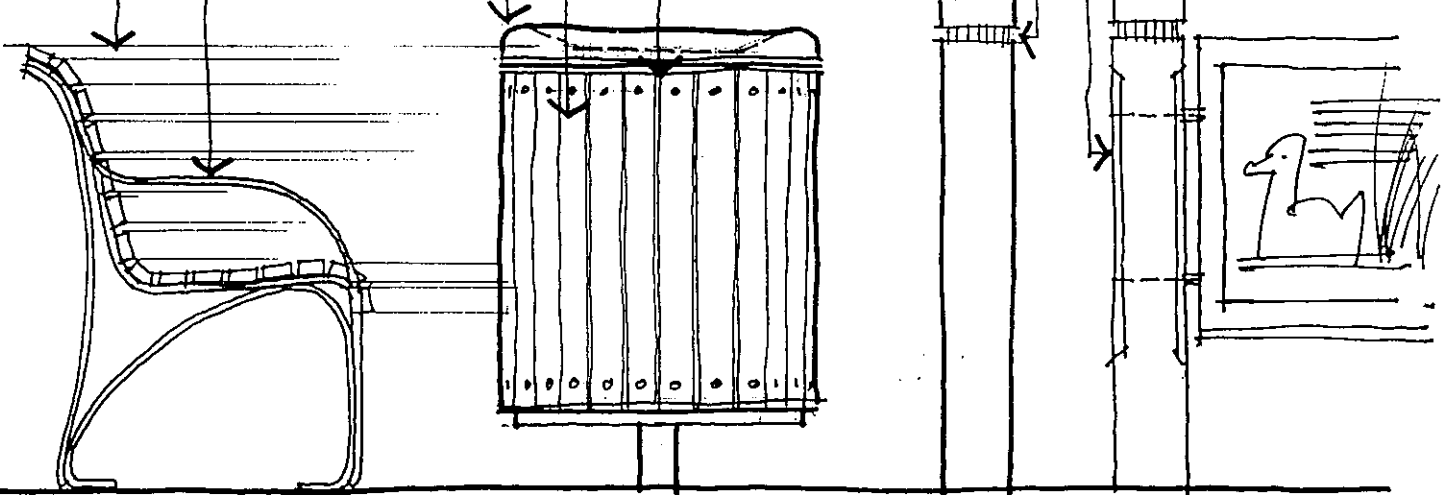

Seat
(MCC. Park Bench)

Litter Bin
(MCC Park Bin)

Timber
Bollard.
(DURABLE
HARDWOOD,
NATURAL
FINISH).

Interpretive
Sign.

WINCHELSEA
TOWNSCAPE
STUDY



Layout and Setback:

Most early shops are built right out to the street frontage. Some of the 1960s shops have a paved forecourt setback. The residential component of mixed use properties and intervening residential lots have garden setbacks. This staggered alignment introduces variety into the streetscape - so individual developments should relate to their immediate street context.

Form:

Most buildings are single storey, and this scale of development is preferred, to avoid isolated interruptions with 2-storey development contrasting the streetscape. If 2-storey development is being considered, it would be preferable to set the second level back from the street frontage.

Pitched roof forms are preferred, with pitches at 35° - 40°.

Verandahs:

Verandahs are relatively common on and over the footpath. The verandahs here are relatively simple structures with plain arised timber, or square metal posts, with simple narrow fascias and gutters, or frieze panels with signage. There are no elaborate decorative cast iron verandahs on the main street.

Finishes:

Where period buildings are constructed of unpainted red brick, polychrome brick or bluestone masonry, the natural finish should be retained.

Existing timber and other painted finishes are mostly coloured white, off-white, butt and cream - these neutral tones are preferred. Highlight trim with darker creams, beiges and 'period' theme colours, such as olive, or other darker trim can be used.

Garish, bright and primary colours should be avoided.

Signage:

Commercial signage is an important part of the vitality of the town.

High quality shopfront signage can enhance both the 'period' and townscape character of Winchelsea. Signage should not be ad hoc, uncontrolled, or garish. It should not obscure the shopfront display, or the architectural integrity of period shopfronts. Figure 25 shows appropriate locations for signs.

NOTE: THESE DIAGRAMS ARE INTENDED AS A FINDING FRAMEWORK TO BUILD ON SOME OF THE SITUAL VISUAL CHARACTER OF THE STREETSCAPE. THEY ARE NOT INTENDED AS PRESCRIPTIVE RULES.

MARK MCWHARD
LANDSCAPE
ARCHITECT
2/398 SMITH ST
COLLINGWOOD 3066
PH 416 1755 FX 416 0508

SIGNAGE:

- Signage not to obscure shopfront display, or quality of architectural fabric. See guide line areas indicated.

SINGLE STOREY CONSTRUCTION

- preferred. Any 2nd level to be set back from street frontage.

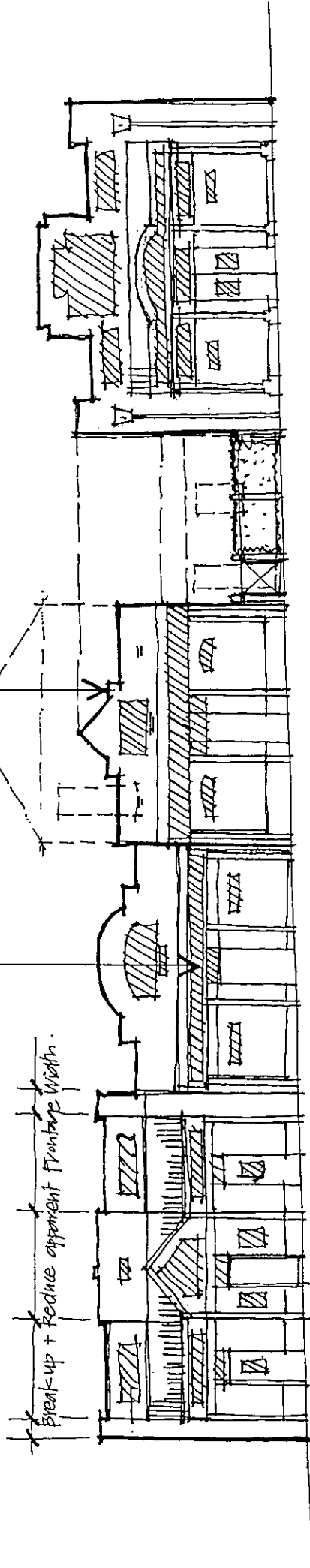

ALLOTMENT/BUILDING FRONTAGE:

- Building frontages to maintain scale of typical narrow (6-10m) shopfront, with buildings + shopfronts stepping up the slope.
- Avoid continuous horizontal forms and break elevations up into smaller parts.
- Maintain window displays to promote streetscape life + vitality.

MATERIALS:

- Simple metal or timber window frames, avoid tinted or mirror glass
- Brickwork to have painted finish
- Roofs - corrugated iron

COLOURS

- Background colours - cream, buff, beige
- Highlight/trim - background colours
- Painted up into stronger colour, olives or heritage colours
- Avoid garish/bright/primary colours.

VERANDAHs:

- Maintain continuity of existing simplicity of verandahs:
- plain arched timber corrugated iron, simple narrow fascias + gutters.

WINCHELSEA
TOWNSCAPE
STUDY



ARCHITECTURAL GUIDELINES

6.0 IMPLEMENTATION

6.1 PRIORITIES FOR IMPLEMENTATION AND STAGING

Because of the significant scope of the proposals put forward in this report it will be necessary to stage the works over a number of years. It will be important for the Shire Council and the community to establish the priorities and order of staging.

An appropriate and realistic time scale would be in the order of five to ten years, as funds and resources become available.

Some works will require a special capital investment; some grants may be sourced, some may be funded by established yearly budget and maintenance allocations - such as street tree planting.

The following list is a first attempt at prioritising the main proposals. Community review of this list may re-order the elements. Some of these works can be concurrent; some may be undertaken by community groups or service organisations as a special project.

1. Main Street Tree Planting
2. Toilet Facilities (South Side)
3. Gravel carpark and Turnaround (South Picnic Area)
4. Carpark Rationalisation and Path Link (North Side Toilets Area)
5. Rotunda and Island (Front of Barwon Hotel Area)
6. Kerb Outstands and Trailer Parking Islands and Trees (Shops Area)
7. Link Paths from east to west under bridge.
8. Street Furniture Upgrade
9. Picnic Shelter (South Side)
10. Highway Gateway Plantations
11. Guye Reserve Area Upgrade, Planting
12. Picnic Shelters (North Side) and Mud Brick Shelter removal
Baths carpark upgrade.
13. Playground Upgrade (North Side)
14. Viewing Deck and Boardwalks at points along river
15. Secondary Streets Avenue Planting
16. Ford Crossing of River
17. Baths Buildings Upgrade
18. Shared Footway to Barwon Park
19. Upgrade Open Space and Carpark at Shire Hall.

6.2 COST ESTIMATES

The following schedule provides preliminary cost estimates for some of the key items proposed. The estimates are based on current trade prices for installed elements experienced by the consultants in late 1995. No allowance is made for inflation. Prices may vary significantly from these figures after detailed design development and review of the proposals.

Item:	Cost (\$)
Toilet Block	40-50,000 (item)
Rotunda	10-15,000 (item)
Picnic Shelter	6-10,000 (item)
Boardwalk Deck (1.2m wide)	50-75 lin metre
Bitumen Path (2.0m. wide)	60-70 lin metre
Seats	750-1,000 each
Litter Bin	600-750 each
Timber Bollard	150 each
Advanced Street Tree	300 each
Semi-advanced Street Tree	150 each
Tubestock Planting and Surround	10 each